

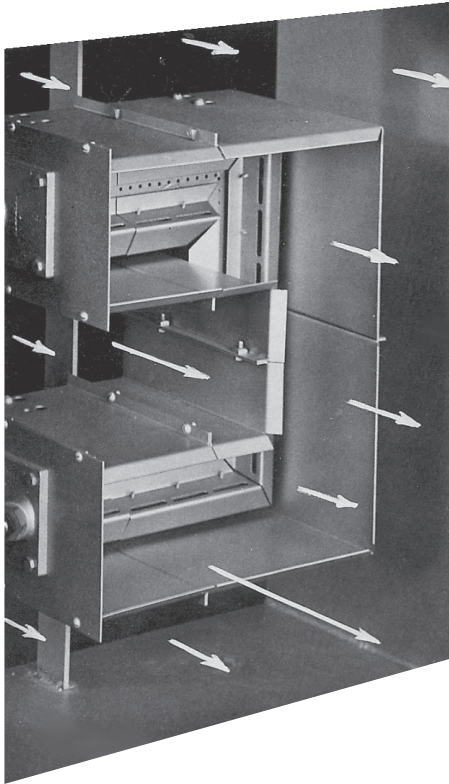

## ***OVEN ZEPHYR GAS BURNERS***



**...for air heaters and recirculating ovens**

- **USE AIR FROM DUCT--no combustion air blower required**
- **HIGH INPUT/LOW UNIT COST--1 000 000 Btu/hr per lineal foot**
- **15 TO 1 TURNDOWN--modulating over entire range**
- **LOW GAS PRESSURE REQUIRED--only 3"wc higher than duct pressure**
- **WIDE RANGE OF SIZES available to fit any duct**
- **ALL METAL CONSTRUCTION--no refractory**
- **EASILY INSTALLED in any position**

4979 Oven Zephyrs are continuous flame gas burners for direct-fired recirculating air heaters and ovens. Duct air is used for combustion--no separate combustion blower is required. The Oven Zephyr's high turndown characteristics (15 to 1) allow precise temperature control of recirculating air. The flame is predominantly blue and cannot flash back because gas alone is delivered to the burner.

**Each lineal foot of burner has a heat release of 1 000 000 Btu/hr.** This exceptionally high rating lowers installation cost by keeping burner lengths to a minimum.

**Fresh air must be present** to maintain stable combustion. Combustion air is supplied from the duct air stream. **The percentage of make-up air** required varies with the temperature rise across the burner--see Table 1. Recirculating air applications involving moisture removal should be referred to North American's home office for evaluation.

**TABLE 1. Minimum % fresh make-up air requirements, assuming no moisture content.**

<u>temperature rise</u>	<u>minimum make-up air</u>
100 degrees (F)	11%
200	22%
300	29%
400	36%

**Practical, durable construction.** Burner air baffles are made with large openings to reduce deposition of airborne material.

**TABLE 2. Burner sections**

4979-6	straight, 6"	(500 000 Btu/hr)
4979-6-B	straight, 6", 2 1/2" bottom inlet	(500 000 Btu/hr)
4979-12	straight, 12"	(1 000 000 Btu/hr)
4979-12-B	straight, 12", 2 1/2" bottom inlet	(1 000 000 Btu/hr)
4979-12-LI	elbow, 6" x 6"†	(1 000 000 Btu/hr)
4979-12-LO	elbow, 6" x 6"†	(1 000 000 Btu/hr)
4979-FEP	main gas endplate, 2" gas inlet, ignition, and flame rod connections	
4979-SEP	pilot endplate, support, ignition, and flame rod connections	

The burner body is made of sturdy cast iron for good temperature service. Sheet metal parts are heat-resistant aluminized steel. The burner can be used in air streams up to 500 F (upstream air). The temperature rise across the burner should not exceed 400 F, regardless of the inlet temperature.

4979 Oven Zephyrs are available in a variety of shapes to permit assembly in a configuration that will provide uniform heat distribution in the duct. See Table 2.

**Flame Supervision.** The burner endplate has provision for mounting a flame rod or UV scanner.

**Two ignition methods** are available: The burner can be lighted with a gas pilot or with a direct spark electrode.

**Air velocity.** The Oven Zephyr is designed for use in air streams having a uniform velocity of 1000 to 1500 feet per minute, and for best operation, air velocity should be constant.

The duct section at the burner should be restricted with a curtain or silhouette plate at the discharge end of the burner to give a velocity of about 3500 feet per minute, which will cause a pressure drop of about 0.75"wc.

**Installation.** The Oven Zephyr can be installed in a horizontal or vertical duct, upstream or downstream of the fan. The burner should be in a section of duct where air flow is reasonably straight. Sharp turns, obstructions, or dampers immediately upstream or downstream of the burner must be avoided. A minimum of 5 duct diameters straight duct before the burner is recommended without inlets, mixing baffles, or other restrictions.

The burner arrangement should promote evenly heated air. Use sections that will form a continuous flame approximating the duct cross section.

† Main flame is either on **inside** or **outside** of elbow. Order must specify which elbow is wanted. If in doubt, send sketch of layout.

A curtain or silhouette plate should be located flush with the discharge end of the burner. The plate should be bolted, rather than welded, to the duct walls, to allow some adjustment after installation. No part of the burner should be less than 2" from the curtain or less than 4" from the duct wall.

Every 3' of burner arrangement should be supported. Long lengths can be supported by steel straps fastened to the bolts at burner flanges (with narrow edge of straps facing air flow). End castings are provided with  $\frac{3}{4}$ " fpt tapped holes that can be used for supports.

Access doors should be provided to permit inspection and servicing of the burner. Sight ports or windows are required for observation of the pilot and main flame.

### HOW TO ORDER

1. Calculate required heat input. *Example:* See the sample problem on a paint baking oven, North American Reprint 94, which requires 2 030 000 Btu/hr gross input (2030 cfh natural gas), 788 scfm make-up air, and 39 200 scfm recirculated. For this example, assume the available gas pressure is 1 $\frac{1}{2}$  psi.
2. Select individual burner sections to obtain this rating from Table 2. Each lineal foot of burner is rated at 1 000 000 Btu/hr. Include enough feed connections to supply rated

volume of gas--a 2" connection supplies 3 feet of burner; a 2 $\frac{1}{2}$ " connection supplies 5 feet of burner, but should be centered to assure proper gas distribution. *Example:* The next largest burner input is 2 500 000 Btu/hr, which could be obtained by using one 4979-6-B and two 4979-12's (one on each side of the -6-B). This arrangement would give a good temperature distribution in a rectangular duct.

3. Select 8522 Fast Engineered™ fluid control system.
4. Select ignition method--either gas pilot (Assembly 4-5257-1) or direct spark electrode (Part No. 4-3681-1).
5. Select endplates--either for gas connection or blank. *Example:* Two 4979-SEP endplates. (From Table 2.)

### CURTAIN SIZING PROCEDURE

1. Total burner area perpendicular to air flow (0.5 sq ft per lineal foot) = 0.5 × ft of burner. *Example:* 0.5 × 2.5 = 1.25 sq ft.
2. Total open area required at burner = (scfm recirculated + scfm make-up) ÷ 3500 fpm. *Example:* (39 200 + 788) ÷ 3500 = 11.4 sq ft.
3. Curtain opening = total burner area (1) + open area (2). *Example:* 1.2 + 11.4 = 12.6 sq ft.

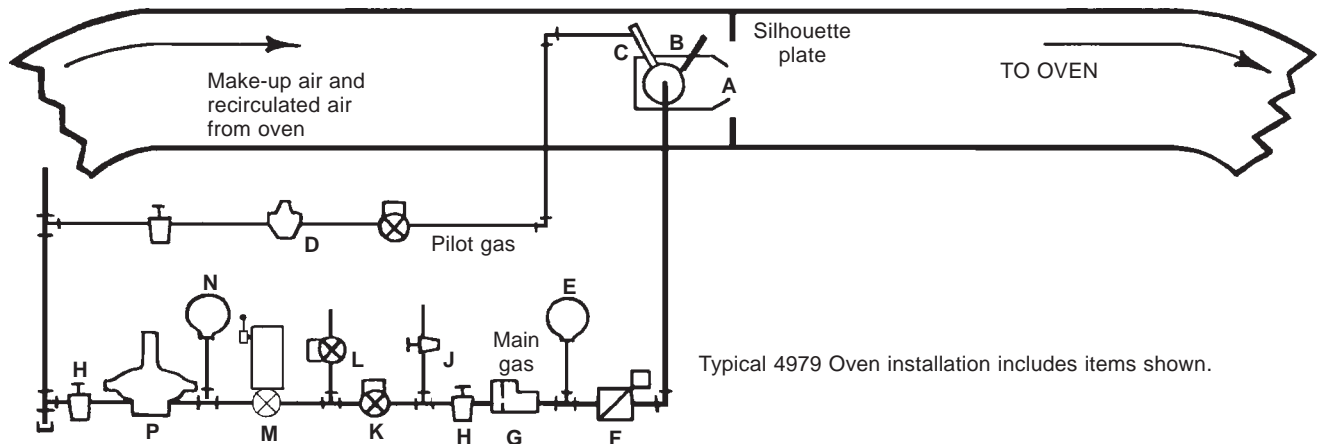

Typical 4979 Oven installation includes items shown.

- |                               |  |
|-------------------------------|--|
| A - 4979 Zephyr Burner        | H - Shutoff Cock                         |
| B - Flame Detector            | J - Test Cock                            |
| C - Pilot Adjusting Cock      | K - Block Valve                          |
| D - Pilot Accessories         | L - Vent Valve                           |
| E - High Gas Pressure Switch  | M - 1518 or 1519 Automatic Shutoff Valve |
| F - Gas Control Valve & Motor | N - Low Gas Pressure Switch              |
| G - Metering Orifice          | P - Main Gas Pressure Regulator          |

**INSTRUCTIONS**  
**(Burner with Gas Pilot)**

- Adjust the profile plates until a differential pressure of 1.0"wc can be read across the duct air pressure taps on the feed endplate (FEP). The burner will operate with any duct differential pressure between 0.30 and 1.50"wc. Air flow at the profile plate must be of uniform velocity and not spinning.
- Ignite the gas pilot and adjust the gas flow (usually by screwdriver adjustment in the gas cock) until flame is about 6" long and a good flame detector signal is obtained.
- Adjust the main gas control valve linkage for desired valve travel.
- Open the 1518 or 1519 Valve. With the control valve wide open, use a metering orifice and manometer to adjust the gas pressure regulator to obtain 1 000 000 Btu/hr for each lineal foot of burner. The flame should then be mostly blue with some yellow tinges and about 24" long with 1"wc duct differential pressure; 30" long with 0.5"wc.
- Adjust and test all burner safety devices--manual reset fuel shutoff valve, purge timer, low fire start, air flow switch, flame safety relay, high and low gas pressure switches, over-temperature control, block and vent valves, etc.

**DIMENSIONS**  
inches

-12 (wt. 21 lb)  
or -6 (wt. 11 lb)

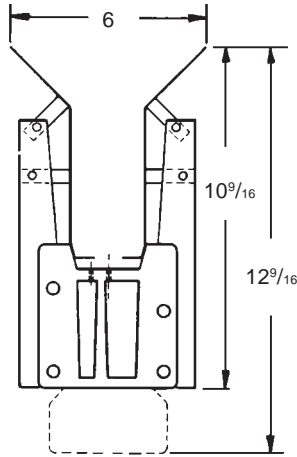

-12-B (wt. 22 lb)  
or -6-B (wt. 12 lb)

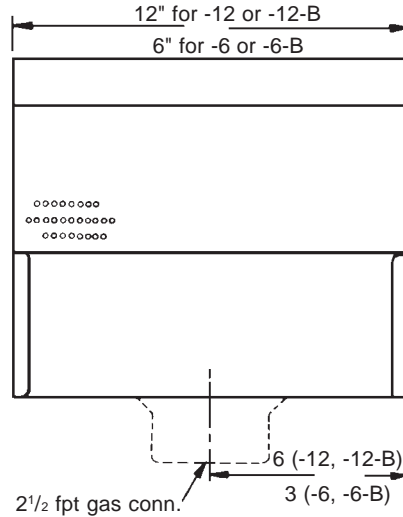

LI or LO  
(wt. 20 lb)

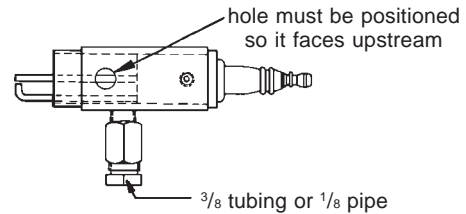
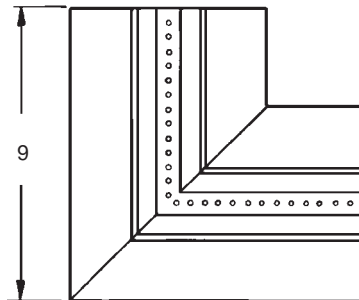

**4-5257-1 Pilot Assembly**

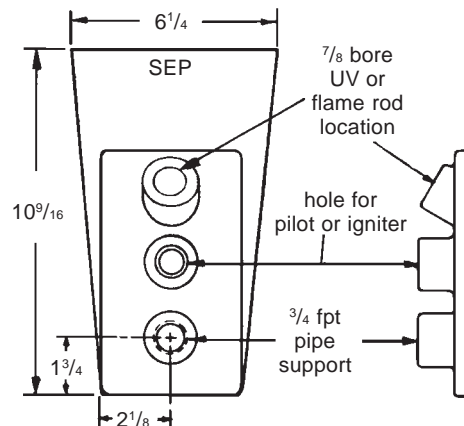
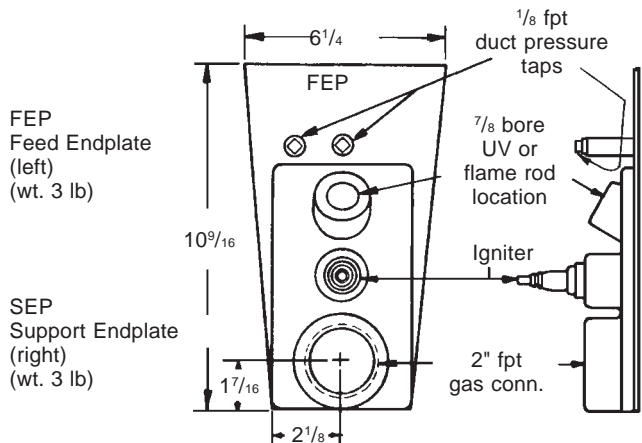

DIMENSIONS SHOWN ARE SUBJECT TO CHANGE. PLEASE OBTAIN CERTIFIED PRINTS FROM NORTH AMERICAN MFG. CO. IF SPACE LIMITATIONS OR OTHER CONSIDERATIONS MAKE EXACT DIMENSION(S) CRITICAL.

**WARNING:** Situations dangerous to personnel and property can develop from incorrect operation of combustion equipment. North American urges compliance with National Safety Standards and Insurance Underwriters recommendations, and care in operation.