

NACA SERIES STANDARD DAMPER ACTUATOR

2 Point & 3 Point Control
20 Nm

NENUTEC[®]

INNOVATIVE MEMBER OF SWISSTECH

NENUTEC ASIA PACIFIC PTE LTD
7030 Ang Mo Kio Ave 5
#03-56 Northstar @ AMK
Singapore 569 880













 (65) 6570 3233

 (65) 6570 6783

 info@nenutec.com.sg

DAMPER ACTUATOR MODEL CHART

MODEL	 NACA	 NACM	 NECA	 NECM	 NASA	 NASM	 NAFA	 SAFA	 SASA	 NSVA
VOLTAGE 230VAC ~ 24VAC/DC	●	●	●	●	●	●	●	●	●	24 VAC
TORQUE (NM)	2 ; 5 ; 10 ; 20 ; 40	2 ; 5 ; 10 ; 20 ; 40	5 ; 10 ; 20	5 ; 10 ; 20	10 ; 20	10 ; 20	3 ; 5 ; 8 ; 20	3 ; 5 ; 8 ; 20	10 ; 15	5
CONTROL	2/3 pts	Modulating	2 pts	Modulating	2/3 pts	Modulating	2 pts SR	2 pts SR	3 pts	Modulating
SPECIAL TYPE										
ELECTRONIC RETURN			●	●						
FAST RUNNING					●	●			●	
SPRING RETURN							●			
FIRE & SMOKE SPRING RETURN								●		
SMOKE SAFETY								●	●	
NETWORKING										●

TYPE DESIGNATION

TYPE	ACTUATOR	DESIGNATION	CONTROL	VOLTAGE	DOT	INPUT SIGNAL	HYPHENATED	TOUQE	AUXILIARY SWITCH
N	A	C	M	1	.	1	-	1 0	S1

TYPE	N = Standard Actuator S = Fire & Smoke
ACTUATOR	A = Standard Actuator E = Electronic Return
DESIGNATION	C = Standard Actuator S = Fast Running Actuator F = Spring Back Actuator
CONTROL	A = 2/3 Points M = Modulating
VOLTAGE	1 = 24 VAC/VDC 2 = 230 VAC 3 = 110/120 VAC 4 = 48 VAC

INPUT SIGNAL (NOT APPLICABLE FOR 2/3 POINTS)	1 = 0(2)...10 VDC and 0(4)...20 mA 2 = 0(2)...10 VDC only 3 = 0...135 Ω only 4 = 4...20 mA only
TORQUE	02 = 2 Nm 03 = 3 Nm 05 = 5 Nm 08 = 8 Nm 10 = 10 Nm 15 = 15 Nm 20 = 20 Nm 40 = 40 Nm
AUXILIARY SWITCH / FEEDBACK POTENTIOMETER	None = No Auxiliary or Feedback Potentiometers S1 = 1 x Auxiliary Switch S = 2 x Auxiliary Switches P1 = 1000Ω P2 = 10000Ω P3 = 140Ω

NACA SERIES STANDARD DAMPER ACTUATOR

2 Point & 3 Point Control
20 Nm

NACA...20 (S) SERIES

NACA standard damper actuators are specially designed and produced for applications in the HVAC Systems. Our wide range of NenuTec standard damper actuators has been developed to operate and position air dampers of different sizes.

PRODUCT FEATURE

- Torque 20 Nm
- Power supply AC/DC 24V and AC 230V
- Shaft dimensions - \varnothing 12...20 mm / \square 11...14 mm
- Minimum Shaft Length 40 mm
- Adjustable angle of rotation
- Selectable direction of rotation of reversing actuator
- Actuator with 1 m cable connection
- Optional 2 Adjustable SPDT auxiliary switches
- Manual Over-ride push button when required
- Collaborate with NVCB 9000 Bracket 1



MODEL SELECTION TABLE

MODEL / TYPE	TORQUE	POWER SUPPLY	RUNNING TIME	AUXILIARY SWITCH
NACA 1-20	20 Nm	AC/DC 24 V \pm 10%	100...150 sec	-
NACA 1-20S	20 Nm	AC/DC 24 V \pm 10%	100...150 sec	2 x SPDT (Adjustable)
NACA 2-20	20 Nm	AC 230 V \pm 10%	100...150 sec	-
NACA 2-20S	20 Nm	AC 230 V \pm 10%	100...150 sec	2 x SPDT (Adjustable)

DIMENSION (mm)

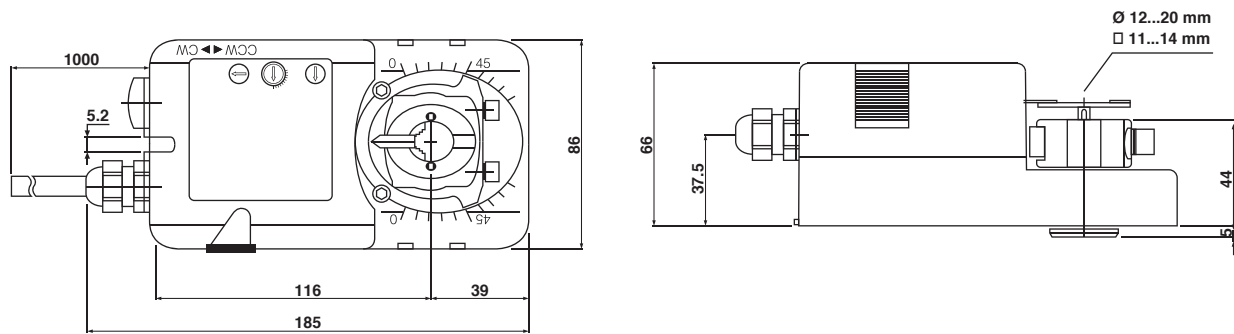

TECHNICAL SPECIFICATION

MODEL NUMBER	NACA 1-20 (S)	NACA 2-20 (S)
TORQUE	20 Nm	20 Nm
DAMPER SIZE	4.0 m ²	4.0 m ²
SHAFT DIMENSION	Ø 12...20 mm / □ 11...14 mm	Ø 12...20 mm / □ 11...14 mm
POWER SUPPLY	AC/DC 24 V ± 10%	AC 230 V ± 10%
FREQUENCY	50...60 Hz	50...60 Hz
CONTROL SIGNAL	2 & 3 point control	2 & 3 point control
POWER CONSUMPTION		
● OPERATING	8.0 W	8.0 W
● END POSITION	2.0 W	2.0 W
FOR WIRE SIZING	14.0 VA	14.0 VA
ELECTRICAL CONNECTION	1 m Cable	1 m Cable
AUXILIARY SWITCHES RATING	3 (1.5) A, AC 250 V	3 (1.5) A, AC 250 V
PROTECTION CLASS	Class III ⚡	Class II ⚡
ANGLE OF ROTATION	90° (95° mechanical)	90° (95° mechanical)
WEIGHT	1.2 Kg	1.2 Kg
LIFE CYCLE	60,000 Rotation	60,000 Rotation
SOUND LEVEL	45 dB	45 dB
IP PROTECTION	IP54	IP54
OPERATING TEMPERATURE	-20°...50° as per IEC 721-3-3	-20°...50° as per IEC 721-3-3
NON-OPERATING TEMPERATURE	-30°...+60° C / IEC 721-3-2	-30°...+60° C / IEC 721-3-2
AMBIENT HUMIDITY	5%...95% rH non condensing / EN	5%...95% rH non condensing / EN
MAINTENANCE	Maintenance Free	Maintenance Free
MODE OF OPERATION	Type I / EN 60730-1	Type I / EN 60730-1
EMC	CE & ISO 9000 EN / EEC	CE & ISO 9000 EN / EEC

NACA SERIES STANDARD DAMPER ACTUATOR

2 Point & 3 Point Control
20 Nm

WIRING DIAGRAM NACA...20 (S) POWER SUPPLY AC/DC 24V / AC 230V

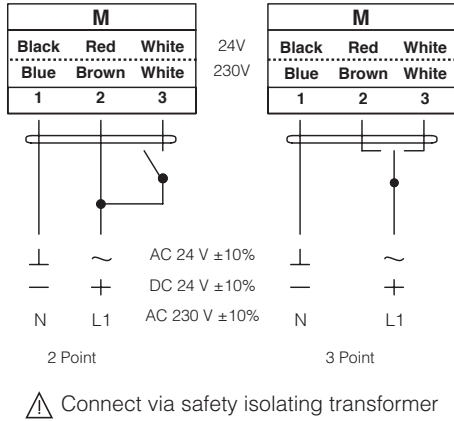

DIRECTION OF ROTATION NACA...20 (S)

Default factory setting: CW.

Direction of rotation can be change by toggling between CW/CCW switch on the actuator's housing.

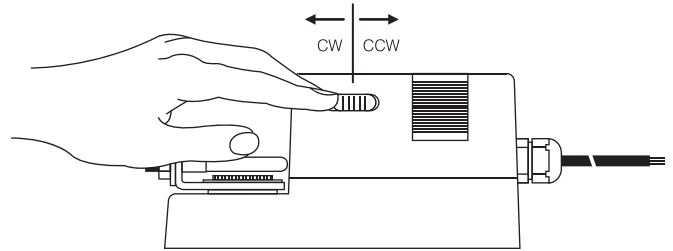

WIRING DIAGRAM NACA...20 (S) AUXILIARY SWITCHES

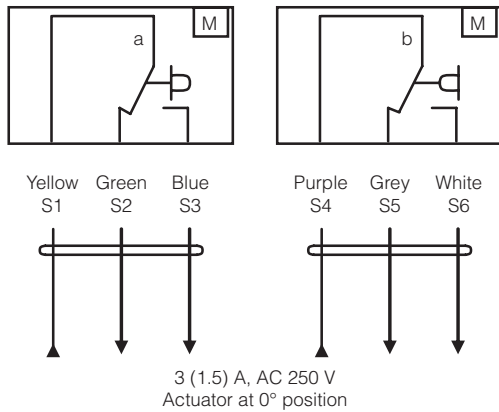

AUXILIARY SWITCH NACA...20 (S)

Switch **a** factory-set at 5° and 85°.

The auxiliary switch can be optimally adjusted between 0°...90°.

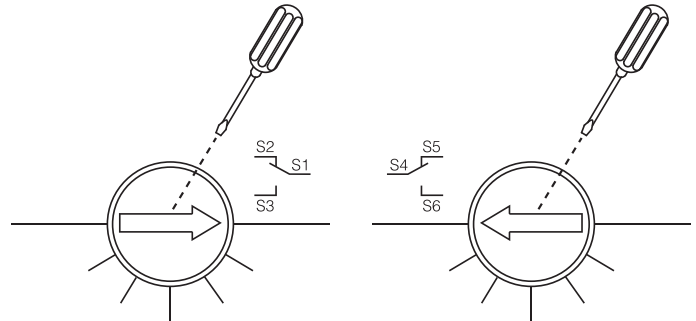

WIRING DIAGRAM NACA...20 (S) PARALLEL CONNECTION

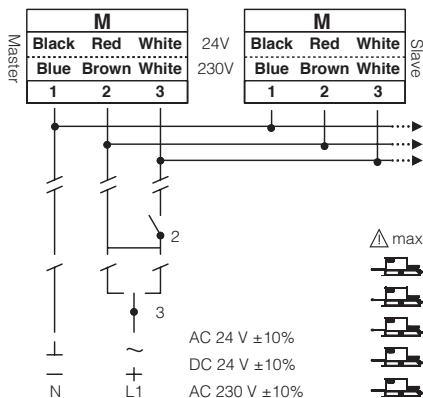

REMARK

Parallel connection of NACA...20 (S) actuators are limited to 5. Power consumption must be observe.

ANGLE OF ROTATION LIMITING

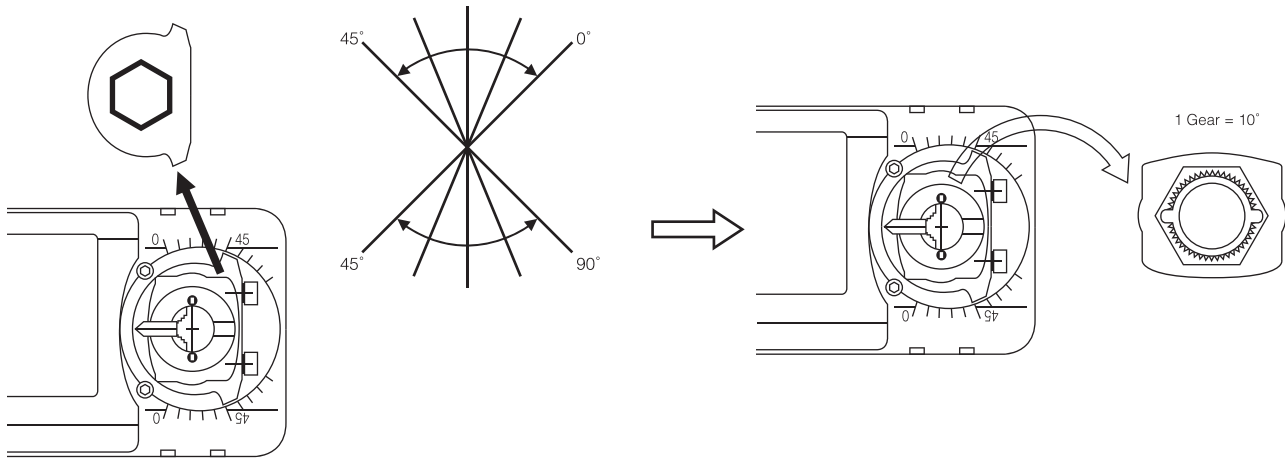

INSTALLATION / MOUNTING INSTRUCTION

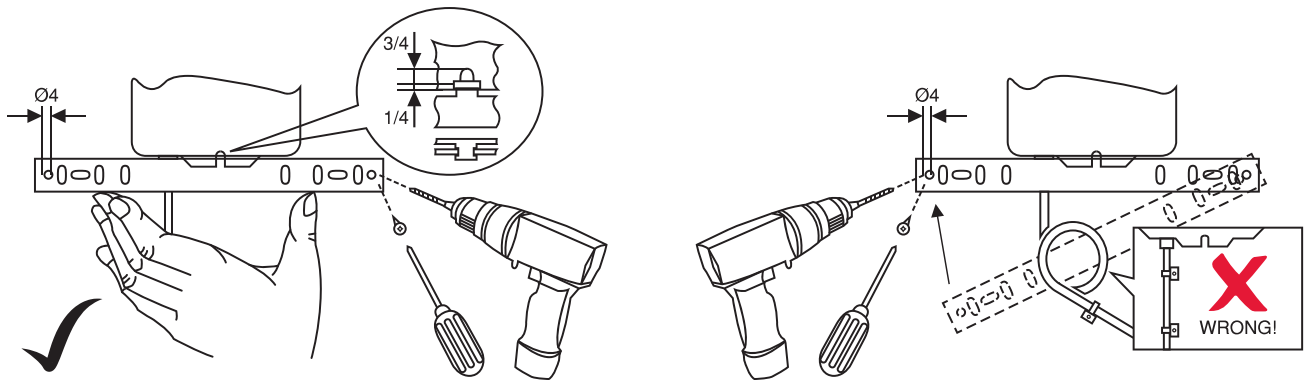

IMPORTANT REMARK

For special requirement, consult your local Nenutec's representative.



This actuator includes electrical and electronic components and may not be disposed as household garbage. Please consider the local valid legislation.



AC / DC 24 V: Connect via safety isolating transformer.
AC 230 V: To isolate from the main power supply, the system must incorporate a device which disconnects the phase conductor (with at least a 3mm contact gap.)

The performance specifications are nominal and conform to acceptable industry standards. NENUTEC shall not be liable for damages resulting from misapplication or misuse of its products.