

SERIES 35-53 "HARMONIZED"

4th Generation 12 VDC Microprocessor Based Direct Spark Ignition Control

F-35-53-04
December 2019

FEATURES

- Combustion blower relay with post-purge
- Available Soft Start (Ramp up/down of Blower)
- System Diagnostic LED
- Single or Multiple tries for ignition (TFI)
- Multiple options for TFI, pre, inter, and post-purge timings
- Meets ANSI 60730-2-5 Harmonized Standards
- Remote or local flame sensing
- Standard Edge and Pin connector
- Integral Standoffs for mounting
- Optional one-hour automatic reset



APPLICATIONS

- Recreational Vehicles (including boats/marine)
 - Furnace, Water Heaters
- Mobile Heating Equipment
 - Agricultural Heaters
 - Construction Equipment
- Process Heating and Flare Stacks

DESCRIPTION

The Model 35-53 "Harmonized" is a 12 VDC Microprocessor Based Direct Spark Ignition Control designed for use in all types of heating applications such as RV gas furnaces and other similar appliances. The control uses a microprocessor to continually and safely monitor, analyze, and control the proper operation of the gas burner. Value added features such as combustion blower control, and multiple ignition tries highlight the control's benefits. The integrated combustion blower version is fully backward compatible with all previous Fenwal Controls 12 VDC controls and competitive models. Additionally the control has an optional soft start feature to reduce ambient noise at startup.

Agency Certifications



Design Certified to ANSI Z21.20-2014
CAN/CSA C22.2 No. 60730-2-5-14 and
UL 60730-2-5



Compliant with current RoHS standards

SPECIFICATIONS

| | |
|-----------------------------------|---|
| Input Power | Control: 9.0 to 15 VDC from a storage battery or full wave rectified unfiltered 50/60 HZ AC |
| Input Current | < 5W, 300 mA @ 12 VDC, combustion blower and gas valve relays energized (control only) |
| Gas Valve | 1.0A @ 12 VDC |
| Combustion Blower Rating | 10.0A @ 12 VDC (w/ Soft Start) 20.0A @ 12 VDC (w/o Soft Start) |
| Operating Temperature | -40°F to + 176°F (-40°C to +80°C) |
| Flame Sensitivity | 0.7 uA minimum |
| Flame Failure Response Rate | 0.8 seconds maximum |
| Flame Failure Lockout Time | Varies by model, 310 seconds maximum |
| Flame Detector Self-check Rate | Once per second minimum |
| Gas Types | Natural, LP, or manufactured |
| Spark Rate | 16 sparks per second |
| Size (LxWxH) | 4.25 x 2.60 x 1.50 inches (10.80 x 6.6 x 3.8 cm) |
| Enclosure / Mounting | Uncovered with integral standoffs |
| Moisture Resistance | Conformal coated to operate to 95% R.H. (Non-Condensing) Always avoid direct exposure to water. |
| Ingress Protection | Not Rated, Protection provided by appliance in which it is installed. |
| Tries for Ignition | One or Three |
| Tries for Ignition Periods | 5, 7, 10, 15, or 24 seconds |
| Pre-purge and Inter-purge Timings | None, 15, or 24 seconds depending on model. Without pre-purge and full-time power, there is a 2 second start-up delay. |
| Post-purge Timings | 45, 90, 130, or 150 seconds |
| Soft Start Timings | 3.5, 5, or 8.4 seconds |

SEQUENCE OF OPERATION / FLAME RECOVERY / SAFETY LOCKOUT

Power Up

During power up the LED shall briefly flash ON for around 1.2 seconds, then turn OFF to indicate normal operation.

Start Up - Heat Mode

When a call for heat is received from the thermostat, 12 VDC to TH, (controls with the soft start option will ramp up the blower) then control will begin a pre-purge delay. Following the pre-purge period, the gas valve is energized and sparking commences for the Trial for Ignition (TFI) period.

When flame is detected during the TFI, the sparking process is terminated and the gas valve remains energized. The thermostat and burner flame inputs are constantly monitored to assure proper system operation. When the thermostat is satisfied and the demand for heat ends, the gas valve is immediately de-energized.

A post-purge delay ensures the unit is ready for the next call for heat, controls with soft start option will ramp down the blower at conclusion of post-purge.

Failure to Light - Lockout

SINGLE TRIAL MODEL

Should the burner fail to light, or a flame is not detected during the TFI period, the gas valve will de-energize and the control will go into lockout. The diagnostic LED will indicate the fault code for ignition lockout. (3 Flashes)

MULTI TRIAL MODEL

Should the burner fail to light or the flame is not detected during the TFI period, the gas valve will de-energize. The control will then go through an inter-purge delay before an additional ignition attempt. The control attempts two additional ignition trials before de-energizing the gas valve and entering lockout. The diagnostic LED will indicate the fault code for ignition lockout. (3 Flashes)

Flame Failure

FLAME FAILURE - RE-IGNITION MODE

If the established flame signal is lost while the burner is operating, the control will respond immediately energizing the H.V. spark for the TFI period in an attempt to relight the flame. If the burner does not light within the TFI, the gas valve will immediately de-energize and single try models will enter lockout. On multi-try models, a new TFI sequence will begin after an inter-purge delay. Multi-try models perform two additional attempts to light the burner before de-energizing the gas valve and entering lockout. If the burner relights, normal operation resumes.

FLAME FAILURE-RECYCLE MODE

With the "Recycle after Loss of Flame" option, upon loss of flame, the gas valve is de-energized and the control proceeds to inter-purge before attempting to relight the flame. Multi-try models permit three tries for ignition including inter-purges. If the burner relights, normal operation resumes. If the burner does not relight, the control will enter lockout.

Combustion Airflow Faults

If the airflow signal is lost, or the hi-limit opens during heat mode, the gas valve is immediately de-energized and the blower stays on. If the switch closes again, a normal ignition sequence will resume. If not and this condition persists for more than five minutes, the control will enter lockout with the blower off.

Lockout Recovery

Recovery from lockout requires a manual reset by either resetting the thermostat, or removing power for a period of 5 seconds. On models with automatic reset, if the thermostat is still calling for heat after one hour, the control will automatically reset and attempt to ignite the burner.

MOUNTING AND WIRING

The 35-53 is not position sensitive and can be mounted vertically or horizontally. The control may be mounted on any surface and fastened with #6 sheet metal screws. Secure the control in an area that will experience a minimum of vibration and remain below the maximum ambient temperature of 176°F (80°C).

All connections should be made with UL approved, 105°C rated, 18 gauge stranded wire with .054" minimum insulation thickness. Refer to the appropriate wiring diagram when connecting the 35-53 to other components in the system.

| | |
|---|---|
|  CAUTION | Label all wires prior to disconnection when servicing or replacing controls. Wiring errors can cause improper and dangerous operation. A functional checkout of a replacement control should always be performed. |
|---|---|

| | |
|---|---|
|  CAUTION | The control must be mounted and located in a manner which protects components from exposure to water (dripping, condensate, spraying, rain). Any control that has been exposed to water must be replaced. |
|---|---|

| | |
|---|---|
|  WARNING | All wiring must be done in accordance with both local and national electrical code, and by a trained service technician. Wiring must be at least #18 AWG rated for 105°C or higher. |
|---|---|

| | |
|---|---|
|  WARNING | The 35-53 uses voltages of shock hazard potential. Wiring and initial operation must be done by qualified service technician. |
|---|---|

| | |
|---|---|
|  WARNING | Operation outside specifications could result in failure of the Fenwal Controls product and other equipment with injury to people and property. |
|---|---|

| | |
|---|--|
|  WARNING | Do not disconnect battery or any electrical loads while the automatic gas ignition control is powered. |
|---|--|

TERMINAL DESIGNATIONS

| Name | Description | Terminal Type | Location | Wire Color** |
|------------|----------------|----------------------------|----------|--------------|
| PWR* | +12 VDC Power | 3/16" male Q.C. | | |
| BLO* | Blower | 1/4" male Q.C. | | |
| AIR* | Airflow Switch | 6 Edge-connect or .156 pin | 1 | Red |
| TH* | Thermostat | 6 Edge-connect or .156 pin | 2 | Orange |
| NC | NC Contact | 6 Edge-connect or .156 pin | 3 | Blue |
| V1 | Gas Valve | 6 Edge-connect or .156 pin | 4 | Brown |
| TEST/SENSE | Local Sense | Unused | 5 | - |
| | Remote Sense | 6 Edge-connect or .156 pin | 5 | Black |
| GND | Ground | 6 Edge-connect or .156 pin | 6 | Yellow |
| HV | H.V. Spark | 1/4" male Q.C. | | |
| LED | Remote LED | .1 pin (optional) | | |

* For applications without blower control, AIR terminal is used to provide +12 VDC power. PWR, BLO, and TH are not used.

** Colors for Fenwal Controls wire harnesses

WIRING DIAGRAMS

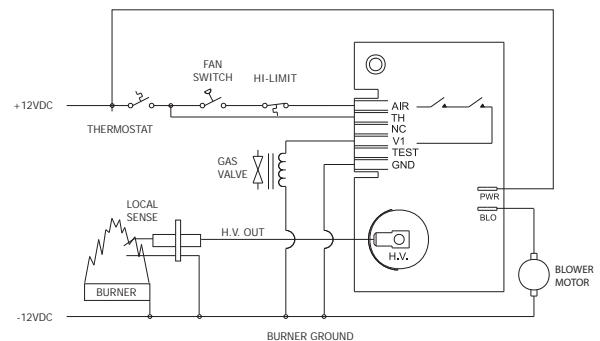

Figure 1. Local Sense with Blower Relay

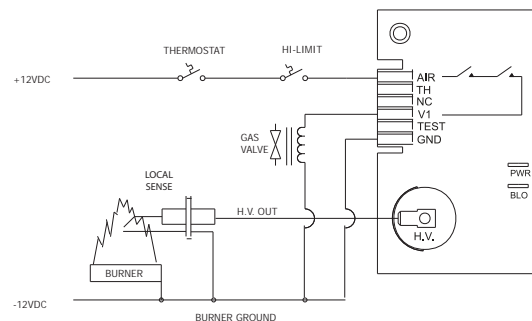

Figure 2. Local Sense without Blower Relay

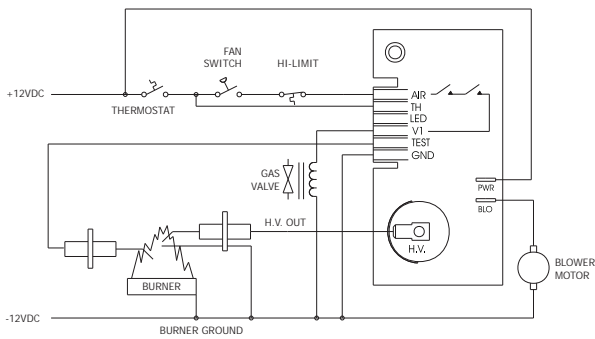

Figure 3. Remote Sense with Blower Relay

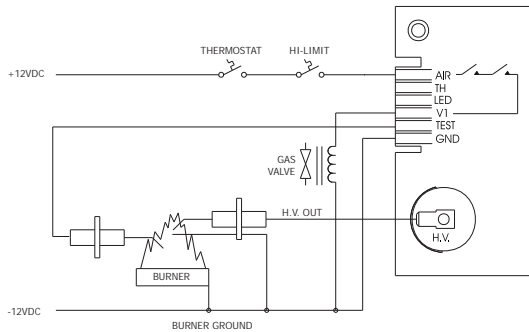

Figure 4. Remote Sense without Blower Relay

DIMENSIONS - INTEGRAL STANDOFF

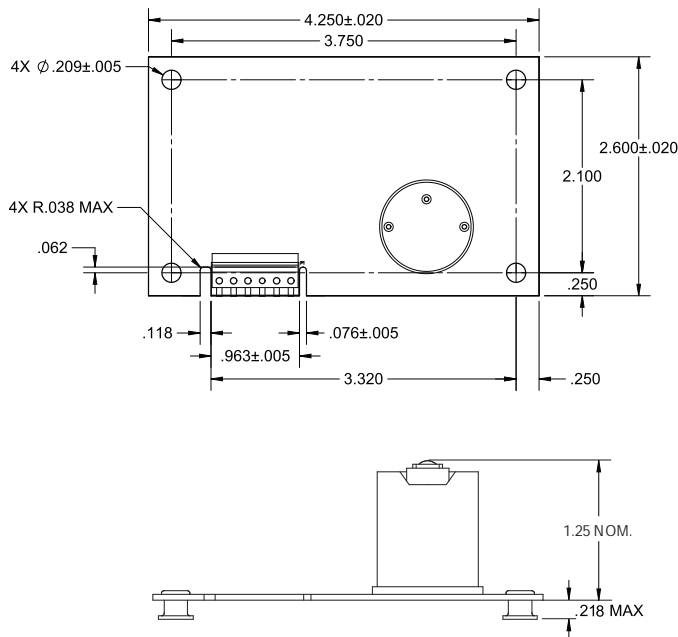

Figure 5. Board Dimensions

CONTROL WIRE HARNESS

Select the proper harness based on the 35-53 control's termination connection.

Standard wire lengths are 12, 18, 24, 30, 36 and 48 inches.

Refer to Fenwal Controls datasheet F-05-1000 for details.

High Voltage and Remote Sense Cable Requirements

The HV Ignition Cable should have a voltage rating of 25KV and an insulation rating of 200°C. Suppression type UL 3257 or SAE J2031 ratings are recommended. Recommend length of 3ft (.9m) or less. Consult factory for longer lengths.

Remote flame sense cable must meet a voltage rating of 250V and an insulation rating of 200°C. Recommended length of 10ft (3m) or less. Consult Factory for longer lengths.

Refer to Fenwal Controls datasheet F-05-1000 for details.

SPARK ELECTRODES/FLAME SENSORS

Critical for gas-fired appliances, proper design, construction, and application assures reliable ignition and optimal performance. Fenwal Controls uses only glazed Alumina ceramics and certified rod materials suitable up to 2175°F (1190°C). Spark electrodes typically have a 0.125" gap between the high voltage (HV) rod tip and the ground rod or burner. Flame sensors are a single rod used in flame rectification circuit of the ignition control to confirm the presence (or absence) of the flame.

Refer to Fenwal Controls datasheet F-22-100 for details.

Proper Electrode Location

Proper location of electrode assembly is important for optimum system performance. The electrode assembly should be located so that the tips are inside the flame envelope and about 1/2-inch (1.2 cm) above the base of the flame as shown:

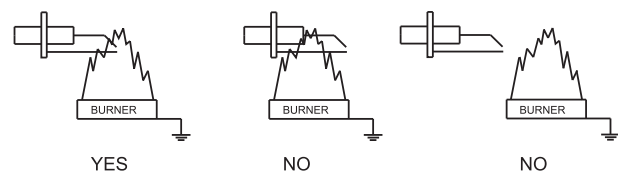

Notes:

- Ceramic insulators must not be in or close to the flame.
- Electrode assemblies must not be adjusted or disassembled. Electrodes are NOT field adjustable.
- Electrodes should have a gap spacing of 0.125 in (3.12 mm), unless otherwise specified by the appliance manufacturer. Larger gaps may not perform as intended in all conditions. If spacing is not correct, the assembly must be replaced.
- Exceeding temperature limits can cause nuisance lockouts and premature electrode failure.
- Electrodes must be located where they are not exposed during normal operation.

Flame Current Measurement

Flame current is the current which passes through the flame from the sensor to ground to complete the primary safety circuit. The minimum flame current necessary to keep the system from lockout is 0.7 μ A. To measure flame current:

1. Disconnect Input Voltage.
2. Insert a 0-50 μ A DC meter and capacitor in series with the sensor electrode and wire as shown below.

The meter should read 0.7 μ A or higher while flame is established. If the meter reads below "0" on the scale, the meter leads are reversed. Disconnect power and reconnect meter leads for proper polarity.

| | |
|---|--|
|  | When monitoring flame current, use a 1.0 μ F, 250 VDC bypass capacitor to protect the meter from damage. |
|---|--|

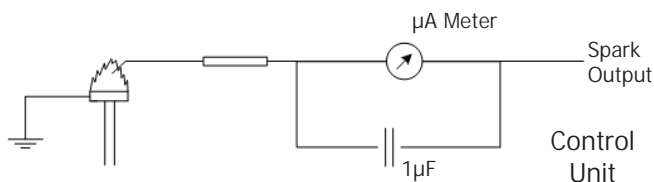

TROUBLESHOOTING

| | |
|---|--|
|  | <p>Risk of Explosion or Fire The 35-53 control cannot be serviced by the user. If any control faults are detected, the 35-53 control must be replaced by qualified service personnel. Risk of explosion or fire can result if the control module has been opened or with any attempts to repair it, and the warranty is void.</p> |
|---|--|

| Troubleshooting Guide | |
|--|--|
| Symptom | Recommended Actions |
| 1. Dead | A. Miswired B. Transformer/battery fault C. Fuse/circuit breaker fault D. No voltage at PWR or AIR E. Faulty control |
| 2. Thermostat on - no blower output | A. Miswired or failed air flow switch B. Faulty thermostat, no voltage at thermostat terminal TH C. Faulty control |
| 3. Airflow Switch input okay, but no TFI after purge delay | A. Miswired B. Faulty control |

Troubleshooting Guide (continued)

| | |
|--|---|
| 4. Valve on, no spark | A. Miswired B. Shorted electrode C. Open HV cable D. Faulty control |
| 5. Spark on, no valve | A. Valve coil open B. Open valve wire C. Faulty control (check voltage between V1 and GND) |
| 6. Flame okay during TFI, no flame sense (after TFI) | A. Faulty electrode B. Faulty HV wire C. Poor ground at burner D. Faulty control (check flame current) |

Fault Conditions - Red diagnostic LED

| LED Indication | Fault Mode |
|--------------------------------------|--------------------------|
| Off | Normal |
| Steady On | Internal Control Failure |
| 1 Flash | Airflow/Limit Fault |
| 2 Flashes | False Flame |
| 3 Flashes | Ignition Lockout Fault |
| 5 Flashes | Low Voltage Fault * |
| * Low Voltage Fault is below 8.7 VDC | |

Note: The code will repeat every 3 seconds. Removing power from the control will clear the fault code.

Internal Control Failure

If the control detects a software or hardware error, all outputs are turned off and the red LED displays a Steady On condition. If this condition persists after an attempt to restart, then the control must be replaced.

PART NUMBER CONFIGURATION

35 – 53 X X X X - X X X

Description

TRIAL FOR IGNITION

1 = 5 SECONDS
 3 = 7 SECONDS
 5 = 10 SECONDS
 7 = 15 SECONDS
 8 = 24 SECONDS

INTER-PURGE

0 = NONE
 1 = 15 SECONDS
 3 = 24 SECONDS

PRE-PURGE

0 = NONE
 1 = 15 SECONDS
 3 = 24 SECONDS

TRIES FOR IGNITION & METHOD OF FLAME SENSE

0 = SINGLE TRY - LOCAL SENSE
 1 = SINGLE TRY - REMOTE SENSE
 5 = THREE TRIES - LOCAL SENSE
 6 = THREE TRIES - REMOTE SENSE

POST-PURGE

3 = 45 SECONDS
 5 = 90 SECONDS
 6 = 130 SECONDS
 7 = 150 SECONDS

RECYCLE/RE-IGNITION & RESET

1 = RECYCLE W/ 1HR AUTO RESET
 2 = RECYCLE W/O RESET
 3 = RE-IGNITION W/ 1HR AUTO RESET
 4 = RE-IGNITION W/O RESET

PRODUCT DESIGNATION

2 = STANDARD MODEL / NON SOFT-START
 3 = OEM SPECIFIC
 4 = SOFT START/STOP (5 SEC)
 6 = SOFT START/STOP (3.5 SEC)
 7 = SOFT START/STOP (8.4 SEC)
 8 = AFTERMARKET KIT
 9 = NON-STANDARD CONFIGURATION

A 3, 8 or 9 in this location indicates a special configuration.

Consult Fenwal Controls for operating characteristics of this control.

EXPORT INFORMATION (USA)

Jurisdiction: EAR
 Classification: EAR99

This document contains technical data subject to the EAR.

All trademarks are property of their respective owners.



Fenwal Controls, Kidde-Fenwal Inc.
 400 Main Street
 Ashland, MA 01721
 Tel: 800-FENWAL-1
 Fax: 508-881-7619
fenwalcontrols.com

This literature is provided for informational purposes only. KIDDE-FENWAL, INC. assumes no responsibility for the product's suitability for a particular application. The product must be properly applied to work correctly. If you need more information on this product, or if you have a particular problem or question, contact KIDDE-FENWAL, INC., Ashland, MA 01721.