

Eclipse ThermAir

Burners

TA Series

Version 2

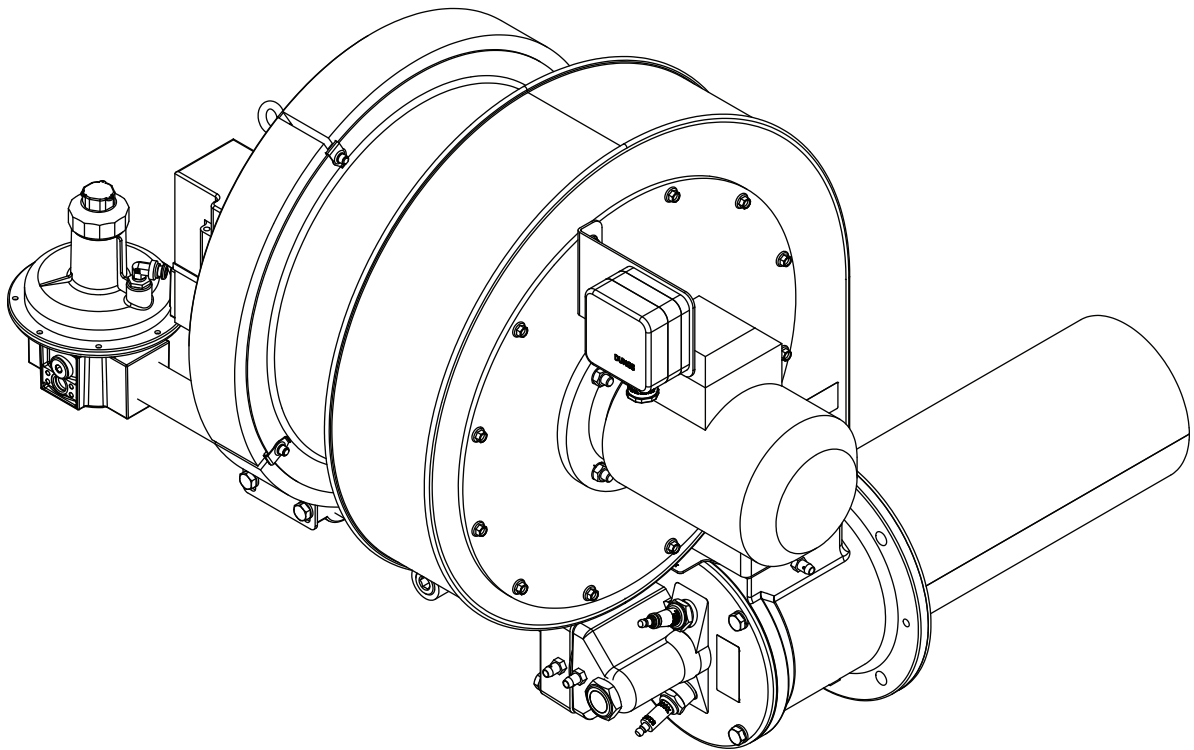

Copyright

Copyright 1998 by Eclipse, Inc. All rights reserved worldwide. This publication is protected by federal regulation and shall not be copied, distributed, transmitted, transcribed or translated into any human or computer language, in any form or by any means, to any third parties, without the express written consent of Eclipse, Inc.

Disclaimer Notice

In accordance with the manufacturer's policy of continual product improvement, the product presented in this brochure is subject to change without notice or obligation.

The material in this manual is believed adequate for the intended use of the product. If the product is used for purposes other than those specified herein, confirmation of validity and suitability must be obtained. Eclipse warrants that the product itself does not infringe upon any United States patents. No further warranty is expressed or implied.

Liability & Warranty

We have made every effort to make this manual as accurate and complete as possible. Should you find errors or omissions, please bring them to our attention so that we may correct them. In this way we hope to improve our product documentation for the benefit of our customers. Please send your corrections and comments to our Marketing Communications Manager.

It must be understood that Eclipse's liability for its product, whether due to breach of warranty, negligence, strict liability, or otherwise is limited to the furnishing of replacement parts and Eclipse will not be liable for any

other injury, loss, damage or expenses, whether direct or consequential, including but not limited to loss of use, income, or damage to material arising in connection with the sale, installation, use of, inability to use, or the repair or replacement of Eclipse's products.

Any operation expressly prohibited in this manual, any adjustment, or assembly procedures not recommended or authorized in these instructions shall void the warranty.

Document Conventions

There are several special symbols in this document. You must know their meaning and importance.

The explanation of these symbols follows below. Please read it thoroughly.

How To Get Help

If you need help, contact your local Eclipse representative. You can also contact Eclipse at:

1665 Elmwood Rd.
Rockford, Illinois 61103 U.S.A.
Phone: 815-877-3031
Fax: 815-877-3336
<http://www.eclipsenet.com>

Please have the information on the product label available when contacting the factory so we may better serve you.

 ECLIPSE <small>Innovative Thermal Solutions</small>	www.eclipsenet.com
Product Name	
Item #	
S/N	
DD MMM YYYY	



This is the safety alert symbol. It is used to alert you to potential personal injury hazards. Obey all safety messages that follow this symbol to avoid possible injury or death.



Indicates a hazardous situation which, if not avoided, will result in death or serious injury.



Indicates a hazardous situation which, if not avoided, could result in death or serious injury.



Indicates a hazardous situation which, if not avoided, could result in minor or moderate injury.

NOTICE

Is used to address practices not related to personal injury.

NOTE

Indicates an important part of text. Read thoroughly.



Table of Contents

Introduction	4
Product Description	4
Audience	4
Purpose	4
Related Documents.....	4
Safety	5
Safety Warnings	5
Capabilities.....	5
Operator Training	5
Replacement Parts.....	5
System Design	6
Step 1: Burner Option Selection.....	6
Step 2: Blower Option Selection.....	8
Step 3: Control Methodology.....	9
Step 4: Trial for Ignition	10
Step 5: Flame Monitoring Control System.....	11
Step 6: Main Gas Shut-Off Valve Train	11
Step 7: Process Temp Control System	11
Appendix	i
Conversion Factors	i
Key to System Schematics.....	ii

Introduction

1

Product Description

The Eclipse ThermAir burner is a nozzle-mixing burner, with a packaged air blower, that is designed to fire with fixed combustion air over a wide gas turndown range. Fixed air operation plus integral air and gas orifices make the ThermAir one of the simplest burners to quickly setup and adjust.

ThermAir burners are ideal on heaters, textile ovens and in situations where the fuel is highly variable (800 BTU/CF to 3200 BTU/CF). They are perfect for ovens needing additional air to carry moisture away from the product being heated.

The burner is designed for:

- Reliable Burner Operation
- Simple Burner Adjustment
- Direct Spark Ignition
- Multiple Fuel Capability

A wide variety of options and configurations are available due to the modular design of the burner.

Audience

This manual has been written for people who are already familiar with all aspects of a nozzle-mix burner and its add-on components, also referred to as “the burner system”.

These aspects are:

- Design / Selection
- Use
- Maintenance

The audience is expected to have previous experience with this type of equipment.

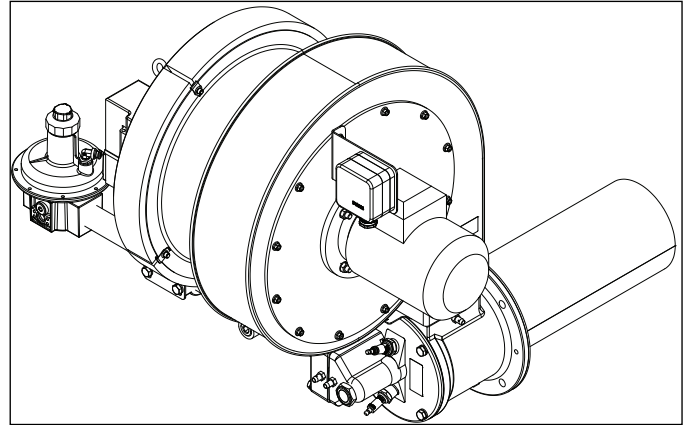

Figure 1.1. ThermAir Burner

ThermAir Documents

Design Guide No. 114

- This document

Datasheet, Series 114

- Available for individual TA models
- Required to complete design and selection

Installation Guide No. 114

- Used with datasheet to complete installation

Spare Part Documents, Series No. 114

- Recommended replacement part information

Related Documents

- EFE 825 (Combustion Engineering Guide)
- 710, 732, 760, 818, 830, 832, 852, 856, 610, 820, 902, 930

Purpose

The purpose of this manual is to ensure that the design of a safe, effective, and trouble-free combustion system is carried out.

Safety

Important notices which help provide safe burner operation will be found in this section. To avoid personal injury and damage to the property or facility, the following warnings must be observed. All involved personnel should read this entire manual carefully before attempting to start or operate this system. If any part of the information in this manual is not understood, contact Eclipse before continuing.

Safety Warnings



DANGER

- **The burners, described herein, are designed to mix fuel with air and burn the resulting mixture. All fuel burning devices are capable of producing fires and explosions if improperly applied, installed, adjusted, controlled or maintained.**
- **Do not bypass any safety feature; fire or explosion could result.**
- **Never try to light a burner if it shows signs of damage or malfunction.**



WARNING

- **The burner and duct sections are likely to have HOT surfaces. Always wear the appropriate protective equipment when approaching the burner.**
- **Eclipse products are designed to minimize the use of materials that contain crystalline silica. Examples of these chemicals are: respirable crystalline silica from bricks, cement or other masonry products and respirable refractory ceramic fibers from insulating blankets, boards, or gaskets. Despite these efforts, dust created by sanding, sawing, grinding, cutting and other construction activities could release crystalline silica. Crystalline silica is known to cause cancer, and health risks from the exposure to these chemicals vary depending on the frequency and length of exposure to these chemicals. To reduce the risk, limit exposure to these chemicals, work in a well-ventilated area and wear approved personal protective safety equipment for these chemicals.**

NOTICE

- **This manual provides information regarding the use of these burners for their specific design purpose. Do not deviate from any instructions or application limits described herein without written approval from Eclipse.**

Capabilities

Only qualified personnel, with sufficient mechanical aptitude and experience with combustion equipment, should adjust, maintain or troubleshoot any mechanical or electrical part of this system.

Operator Training

The best safety precaution is an alert and trained operator. Train new operators thoroughly and have them demonstrate an adequate understanding of the equipment and its operation. A regular retraining schedule should be administered to ensure operators maintain a high degree of proficiency.

Replacement Parts

Order replacement parts from Eclipse only. All Eclipse approved valves or switches should carry UL, FM, CSA, CGA and/or CE approval where applicable.

System Design

3

Design

The design process is divided into the following steps:

1. Burner Option Selection Including:
 - Burner Model / Size
 - Firing Position
 - Burner Configuration
 - Fuel Type
 - Fuel Supply
 - Combustor Type & Material
 - Air Supply
 - Control Motor
 - Limit Switch
 - Loading Line Type
 - Air Pressure Switch
 - Pipe Connection
 - Flame Supervision
2. Blower Option Selection Including:
 - Power Supply Frequency
 - Pressure and Flow
 - Blower Motor Type
 - Blower Inlet
 - Blower Configuration
3. Control Methodology Including:
 - Burner Control
4. Ignition System Including:
 - Ignition Transformer
 - Trial for Ignition
 - Ignition Gas Piping
5. Flame Monitoring Control System Including:
 - Flame Sensor
 - Flame Monitoring Control
6. Main Gas Shut-Off Valve Train Including:
 - Component Selection
 - Valve Train Size
7. Process Temperature Control System

Step 1: Burner Option Selection

Step 1 describes how to select burner options to suit an application. Use the ThermAir Datasheet series 114 when following this selection process.



CAUTION

- **Consult EFE-825 Eclipse Engineering Guide or contact Eclipse if you have special conditions or questions.**

Burner Model / Size Selection

Consider the following when selecting the burner size:

- **Heat Input:** Calculate the required heat input to achieve the required heat balance.
- **Power Supply Frequency:** Burner capacity will vary with power supply frequency (50 Hz or 60 Hz power).
- **Combustion Chamber Pressure:** Consider the effects that large or varying chamber pressures have on burner performance.
- **Altitude:** The maximum burner capacity is reduced by approximately 3% each 1000 feet (300 meters) above sea level.
- **Combustion Air Supply:** Combustion air should be fresh (20.9% O₂) and clean (without particles or corrosives).
- **Combustion Air Temperature:** Changes in air supply temperature can affect the burner capacity. Contact Eclipse if the combustion air temperature exceeds 150°F (65°C).
- **Fuel Type:** Variation in calorific value, specific gravity and WOBBE index will affect burner performance. If any of these parameters change more than 5% from Figure 3.1 contact Eclipse to check the suitability of the fuel. Performance data, dimensions and specifications are given for each ThermAir in Datasheets 114-1 through 114-9.

Firing Position

- Vertical Down Firing
- Vertical Up Firing
- Horizontal Firing

Burner Configuration

Select configuration.

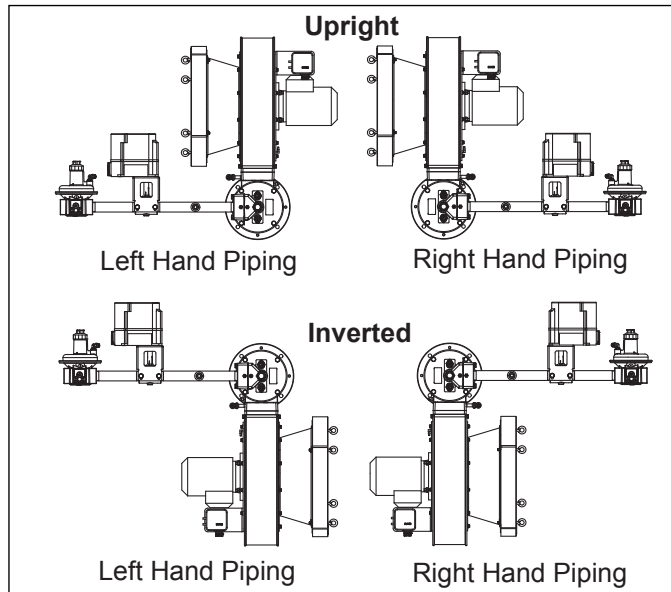

Figure 3.1 Burner Configuration

Fuel Type

Fuel	Symbol	Gross Heating Value	Specific Gravity	WOBBE Index
Natural Gas	CH ₄ 90%+	1000 BTU/ft ³ (40.1 MJ/m ³)	0.60	1290 BTU/ft ³
Propane	C ₃ H ₈	2525 BTU/ft ³ (101.2 MJ/m ³)	1.55	2028 BTU/ft ³
Butane	C ₄ H ₁₀	3330 BTU/ft ³ (133.7 MJ/m ³)	2.09	2303 BTU/ft ³

BTU/ft³ @ standard conditions (MJ/m³ @ normal conditions)

If using an alternative fuel supply, contact Eclipse with an accurate breakdown of the fuel components.

Fuel Supply

Select the turndown required.

Select the gas pipe thread type and the gas control options desired. Gas control options are:

- Stripped, N.P.T. or Rc connections
- Basic, Modulating gas control valve (N.P.T. or Rc)
- Complete, Modulating gas control valve and ratio regulator

The high turndown option includes a ratio regulator with bypass adjustment for lower inputs

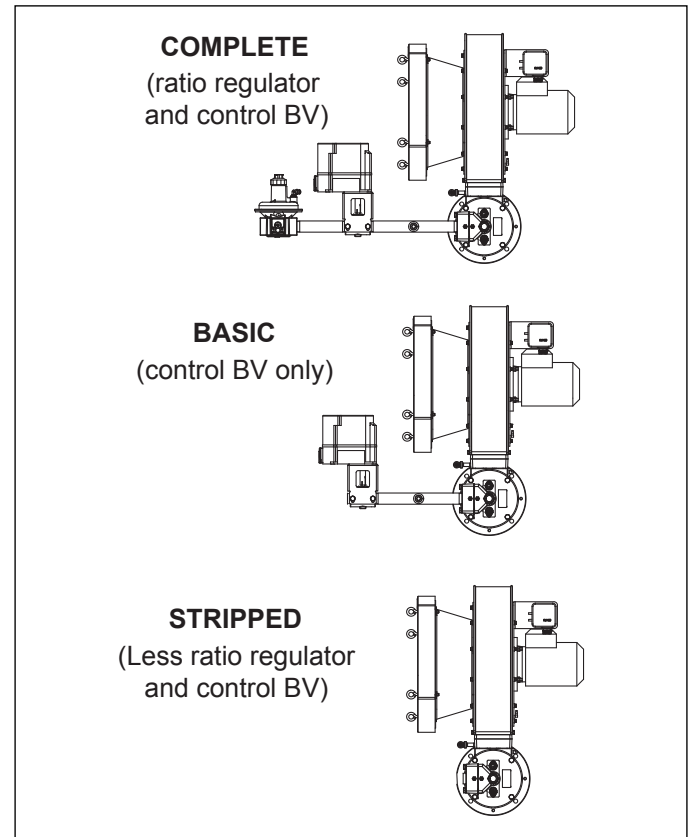

Figure 3.2 Fuel Supply Options

Combustor Type & Material

Select a combustor type based on the application. Low temperature applications use an alloy combustion tube. High temperature applications use a silicon carbide (SiC) tube (sizes 0015-0200) or refractory block and holder (sizes 0300-0500). For vertical down-firing applications with block and holder, contact Eclipse.

Air Supply

The ThermAir burner can be ordered with a combustion air blower supplied and mounted directly to the burner body or, depending on burner size, with a threaded, flanged, or welded inlet to accommodate a remote blower. The remote blower must provide adequate pressure and flow per the appropriate datasheet series 114.

Control Motor

Select a control motor. Eclipse Trilogy T500 actuators are standard on all Eclipse packaged burners, other control motor options are available which Eclipse will mount to the burner. ThermAir burners can be ordered with control motor bracket and mounting hardware only. Customer supplied control motors must conform to these specifications:

- rotation not to exceed 2 rpm
- minimum torque of 25 in-lb (2,8 Nm)
- 90° stroke
- continuous modulating or high/low modulating control
- reversible direction of rotation
- certain applications may require control motors with a limit switch or switches if:
 - the burner capacity is to be limited to fit an application
 - the chamber is to be fired with positive or negative pressure
 - the chamber pressure is outside the range -1" w.c. to +1" w.c. (-2,5 to 2,5 mbar)
 - there is a need to indicate a high and/or low fire air butterfly valve position

Air Pressure Switch

The air pressure switch provides a signal to the monitoring system when there is not enough air pressure from the blower. If a switch is selected, it will be factory mounted.



- **Eclipse supports the NFPA regulation requiring, as a minimum standard for main gas shut-off systems, the use of an air pressure switch in conjunction with other system components.**

Loading Line Type

All ThermAir burners have the option of plastic, flexible braided stainless steel or rigid stainless tube loading line. Selection depends on application and environment.

Pipe Connection

Select the gas pipe connection (pipe thread type).

The piping, burner gas inlet, and ratio regulator are threaded using the customer selected pipe thread option.

Flame Supervision

Determine if a flame rod or an ultraviolet (UV) scanner will be required. Flame rods are available on models TA0015-TA0100 burners with alloy or SiC tubes. All other options and models require UV scanners. If a UV scanner is required, it must be ordered separately.

NOTE: Some flame monitoring devices do not work with alternative fuels. Consult Eclipse for assistance when selecting flame monitoring equipment for alternative fuels.

See Step 5 for additional information on flame supervision selection.



- **A UV scanner could possibly detect another burner's flame if it is in the line of sight, and falsely indicate flame presence.**

Step 2: Blower Option Selection

Standard blower options are listed in datasheet series 114, additional blower options are available through Eclipse. Price and lead time may vary.

Power Supply Frequency

Select the 50Hz or 60Hz option. The 50Hz blower motors have IEC frames and are CE marked. The 60Hz motors have NEMA frames.

Pressure & Flow

Eclipse offers SMJ blowers for remote blower applications. The ThermAir burner can be ordered with a combustion air blower supplied and mounted directly to the burner body or with a threaded, flanged, or welded inlet to accommodate a remote blower. Remote blower must provide adequate pressure and flow per the appropriate datasheet series 114.

Blower Motor Type

Motor types include various options: voltages, single or three phase, TEFC or automotive duty enclosures.

Blower Inlet

When selecting an inlet, consider the following:

- amount and size of particles in the air
- sound requirements
- space limitations
- cleanliness requirements of the process

Blower Configuration

Right-hand blower motor configuration is standard. If left-hand blower configuration is required, contact Eclipse.

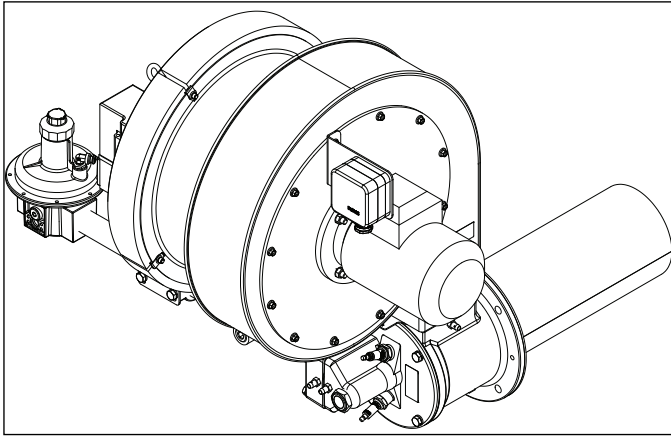

Figure 3.3 Right Hand Blower Motor Orientation

Step 3: Control Methodology

Gas Turndown

The entire ThermAir burner family is capable of gas turndown of greater than 30:1 based upon starting at high fire. A typical single burner installation would be controlled by a modulating gas valve. Leakage flow through this valve in the closed position could exceed the desired low fire input. If this is the case, consider an alternate control method to obtain your desired low fire.

Control Methods

There are numerous gas control options possible to provide a reliable gas control/ignition system. The method of control you select and the type of “Gas Control Options” you select will have a large impact on burner performance and ignition reliability. These options and their variations are outlined in the following schematics.

With Ratio-Regulator

A ThermAir burner equipped with a packaged blower and a ratio-regulator is ignited via direct spark at low fire.

- **Air**

Air flow to the burner is fixed.

- **Gas**

High fire gas flow is limited by a metering gas orifice, sized for a given loading line pressure to the ratio-regulator, installed in the burner at the gas inlet. Gas flow to the burner is controlled by the modulating gas valve in the gas line. Although the Ratio-Regulator does not control gas flow, it will provide for ease of burner set-up and additional safety if there is reduced combustion air pressure and/or flow.

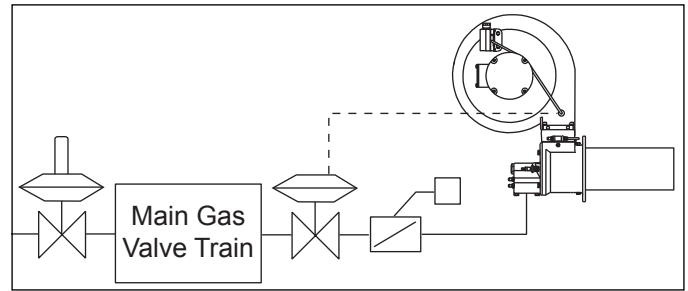

Figure 3.4 Packaged Blower with Ratio-Regulator

Without Ratio-Regulator

Refer to “Packaged Blower Burner Adjustment” in ThermAir Installation Guide for start and stop adjustment instructions.

- **Air**

Air flow to the burner is fixed.

- **Gas**

High fire gas flow of a ThermAir burner not equipped with a ratio-regulator is controlled by the outlet pressure of the main gas pressure regulator. The main gas pressure regulator must be adjusted to change high fire gas flow.

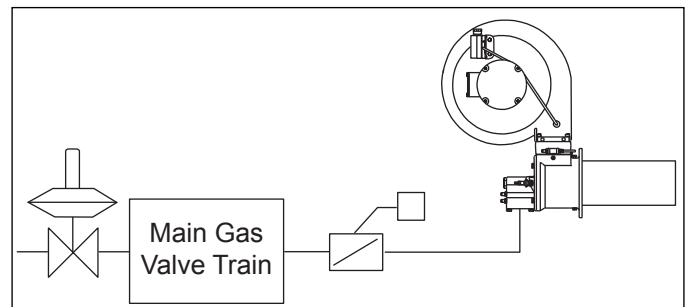

Figure 3.5 Packaged Blower without Ratio-Regulator

The Use of Blocking Valves

NOTE: The position of the gas blocking valve(s) relative to the ratio-regulator will have an impact on burner performance.

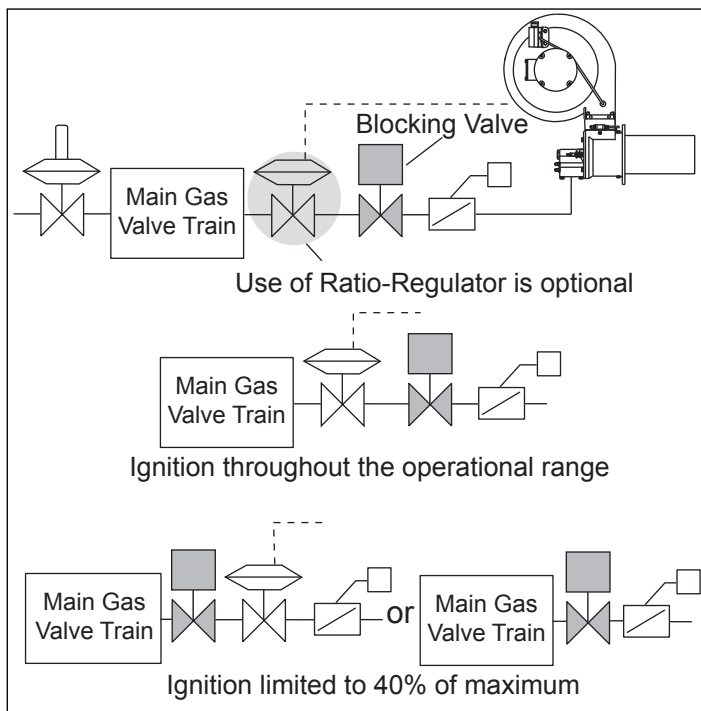

Figure 3.6 Use of Blocking Valves

Step 4: Trial for Ignition

It is recommended that low fire start be used. Local safety and insurance codes require limits on the maximum trial for ignition period. These limits vary from one location to the next. Ensure that you are in compliance with the strictest requirement applicable to your installation.

The time it takes for a burner to ignite depends upon:

- the distance from the gas shut-off valve to the burner
- the gas flow conditions at start-up

It is possible to have low fire too low to ignite the burner within the maximum trial for ignition period. Under these circumstances you must consider one of the following options:

- start at higher input level
- resize and/or relocate the gas controls
- use bypass start gas

Bypass Start Gas (Optional)

A bypass start gas circuit provides gas flow around gas control valves during the trial for ignition period. Bypass start gas may be required if the automatic gas control valves are not located close to the burner.

The solenoid valve in the bypass line plus the automatic gas shut-off valves are opened during the trial for ignition period. If a flame is established, the bypass solenoid closes at the end of the trial for ignition period while the automatic gas control valves remain open. If a flame is not

established, then both the bypass solenoid and the automatic shut-off valves close.

Bypass Start Gas Circuit Schematics

Key points to consider when providing bypass start gas for ignition.

- Locate the bypass solenoid valve as close to the burner as possible.
- Provide some means for flow adjustment.
- To provide the bypass start gas circuit with a constant gas pressure:
 - Connect to the main gas line downstream of the main gas pressure regulator. (See Figure 3.7)
 - Provide a bypass gas pressure regulator. (See Figure 3.8)
- The downstream gas connection can be either through the peepsight location in the rear cover or into the main gas line to the burner.

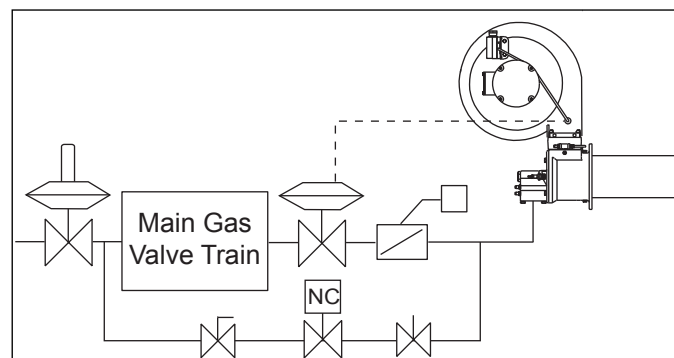

Figure 3.7 Bypass Gas Pressure Regulator via Main Gas Pressure Regulator

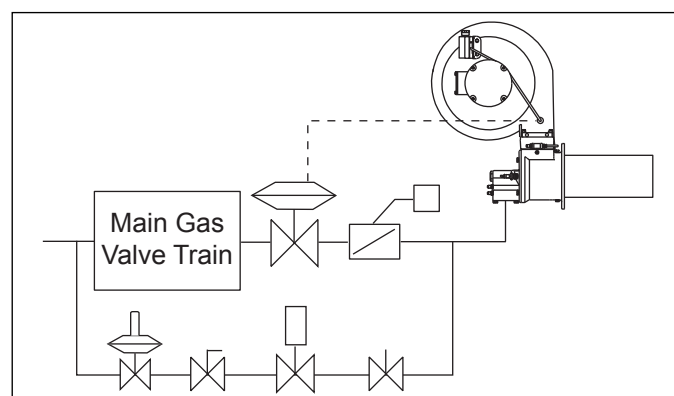

Figure 3.8 Bypass Gas Pressure Regulator via Independent Pressure Regulator

Ignition Transformer

For the ignition system, use a transformer with:

- secondary voltage 6000 to 8000 VAC
- minimum secondary current 0.02 amps
- full wave output

DO NOT USE the following:

- twin outlet
- distributor type
- electronic type

Step 5: Flame Monitoring Control System

The flame monitoring control system consists of two main components:

- Flame Sensor
- Flame Monitoring Control

Flame Sensor

Two types can be used on a ThermAir Burner:

- Flamerod
- UV scanner.

Flamerods are available on model TA0015-TA0100 burners with alloy or SiC tubes. Further information about flamerods can be found in:

- Info Guide 832

A UV scanner can be used on all ThermAir burner sizes. The UV scanner must be compatible to the flame monitoring control that is used. Refer to the manual of your selected control for proper selection of the scanner.

Flame Monitoring Control

The flame monitoring control is the equipment that processes the signal from the flame sensor and controls the start-up and shut-down sequences.

For flame monitoring control you may select several options:

- flame monitoring control for each burner: if one burner goes down, only that burner will be shut off
- multiple burner flame monitoring control: if one burner goes down, all burners will be shut off

Eclipse recommends the following flame monitoring controls:

- Trilogy series T400; see Instruction Manual 830
- Veri-Flame series 5600; see Instruction Manual 818
- Bi-Flame series 6500; see Instruction Manual 826
- Multi-Flame series 6000; see Instruction Manual 820

NOTICE

- **If other controls are considered, contact Eclipse to determine how burner performance may be affected. Flame monitoring controls that have lower sensitivity flame detecting circuits may limit**

burner turndown and change the requirements for ignition. Flame monitoring controls that stop the spark as soon as a signal is detected may prevent establishment of flame, particularly when using UV scanners. The flame monitoring control must maintain the spark for a fixed time interval that is long enough for ignition.

DO NOT USE the following:

- Flame monitoring relays which interrupt the trial for ignition when the flame is detected.
- Flame sensors which supply a weak signal.
- Flame monitoring relays with low sensitivity.

Step 6: Main Gas Shut-Off Valve Train

Component Selection

Eclipse can help in the design of a main gas shutoff valve train that satisfies the customer and complies with all local safety standards and codes set by the authorities within that jurisdiction. Contact Eclipse for further information.

NOTE: Eclipse supports NFPA regulations (two gas shut-off valves as a minimum standard for main gas shutoff systems).

Valve Train Size

Fuel pressure supplied to the ratio regulator inlet (when used) must be at least 15" w.c. (37.5mbar). It should not exceed the maximum pressure rating of the ratio-regulator. The valve train should be sized sufficiently to provide the specified pressure.



WARNING

- **Do not operate ThermAir burners with gas inlet pressure less than the loading line pressure. Lower gas inlet pressures may cause the ratio regulator to remain fully open with reduced air flow. This could result in the possible accumulation of unburned fuel in the burner which, in extreme situations, could cause a fire or an explosion.**

Step 7: Process Temp Control System

Consult Eclipse

The process temperature control system is used to control and monitor the temperature of the system. There is a wide variety of control and measuring equipment available.

For details, please contact Eclipse.



Appendix

Conversion Factors

Metric to English

From	To	Multiply By
actual cubic meter/h (am ³ /h)	actual cubic foot/h (acfh)	35.31
normal cubic meter/h (Nm ³ /h)	standard cubic foot /h (scfh)	38.04
degrees Celsius (°C)	degrees Fahrenheit (°F)	(°C x 9/5) + 32
kilogram (kg)	pound (lb)	2.205
kilowatt (kW)	Btu/h	3415
meter (m)	foot (ft)	3.281
millibar (mbar)	inches water column ("w.c.)	0.402
millibar (mbar)	pounds/sq in (psi)	14.5 x 10 ⁻³
millimeter (mm)	inch (in)	3.94 x 10 ⁻²
MJ/Nm ³	Btu/ft ³ (standard)	26.86

Metric to Metric

From	To	Multiply By
kiloPascals (kPa)	millibar (mbar)	10
meter (m)	millimeter (mm)	1000
millibar (mbar)	kiloPascals (kPa)	0.1
millimeter (mm)	meter (m)	0.001











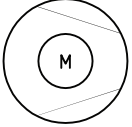
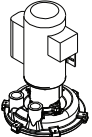
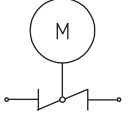
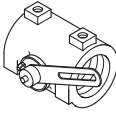
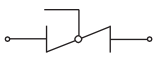
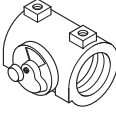
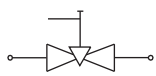

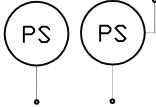
English to Metric

From	To	Multiply By
actual cubic foot/h (acfh)	actual cubic meter/h (am ³ /h)	2.832 x 10 ⁻²
standard cubic foot /h (scfh)	normal cubic meter/h (Nm ³ /h)	2.629 x 10 ⁻²
degrees Fahrenheit (°F)	degrees Celsius (°C)	(°F - 32) x 5/9
pound (lb)	kilogram (kg)	0.454
Btu/h	kilowatt (kW)	0.293 x 10 ⁻³
foot (ft)	meter (m)	0.3048
inches water column ("w.c.)	millibar (mbar)	2.489
pounds/sq in (psi)	millibar (mbar)	68.95
inch (in)	millimeter (mm)	25.4
Btu/ft ³ (standard)	MJ/Nm ³	37.2 x 10 ⁻³

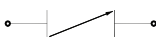

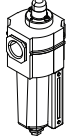
System Schematics

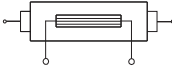
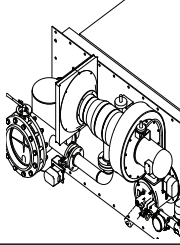
Symbol	Appearance	Name	Remarks	Bulletin/ Info Guide
		Gas Cock	Gas cocks are used to manually shut off the gas supply.	710
		Ratio Regulator	A ratio regulator is used to control the air/gas ratio. The ratio regulator is a sealed unit that adjusts the gas pressure in ratio with the air pressure. To do this, it measures the air pressure with a pressure sensing line, the impulse line. This impulse line is connected between the top of the ratio regulator and the burner body.	742
		Main Gas Shut-Off Valve Train	Eclipse strongly endorses NFPA as a minimum.	790/791
		Pilot Gas Valve Train	Eclipse strongly endorses NFPA as a minimum.	790/791
		Automatic Shut-Off Valve	Shut-off valves are used to automatically shut off the gas supply on a gas system or a burner.	760
		Orifice Meter	Orifice meters are used to measure flow.	930
		Combustion Air Blower	The combustion air blower provides the combustion air to the burner(s).	610

Symbol	Appearance	Name	Remarks	Bulletin/ Info Guide
		Hermetic Booster	Booster is used to increase gas pressure.	620
		Automatic Butterfly Valve	Automatic butterfly valves are typically used to set the output of the system.	720
		Manual Butterfly Valve	Manual butterfly valve are used to balance the air or gas flow at each burner.	720
		Adjustable Limiting Orifice	Adjustable limiting orifices are used for fine adjustment of gas flow.	728/730
		Pressure Switch	A switch activated by rise or fall in pressure. A manual reset version requires pushing a button to transfer the contacts when the pressure set point is satisfied.	840
		Pressure Gauge	A device to indicate pressure.	940
		Check Valve	A check valve permits flow only in one direction and is used to prevent back flow of gas.	780
		Strainer	A strainer traps sediment to prevent blockage of sensitive components downstream.	
		Flexible Connector	Flexible connectors isolate components from vibration, mechanical, and thermal stresses.	
		Heat Exchanger	Heat exchangers transfer heat from one medium to another.	500
		Pressure Taps	Pressure taps measure static pressure.	

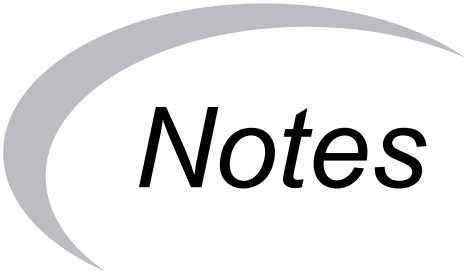

Notes

