

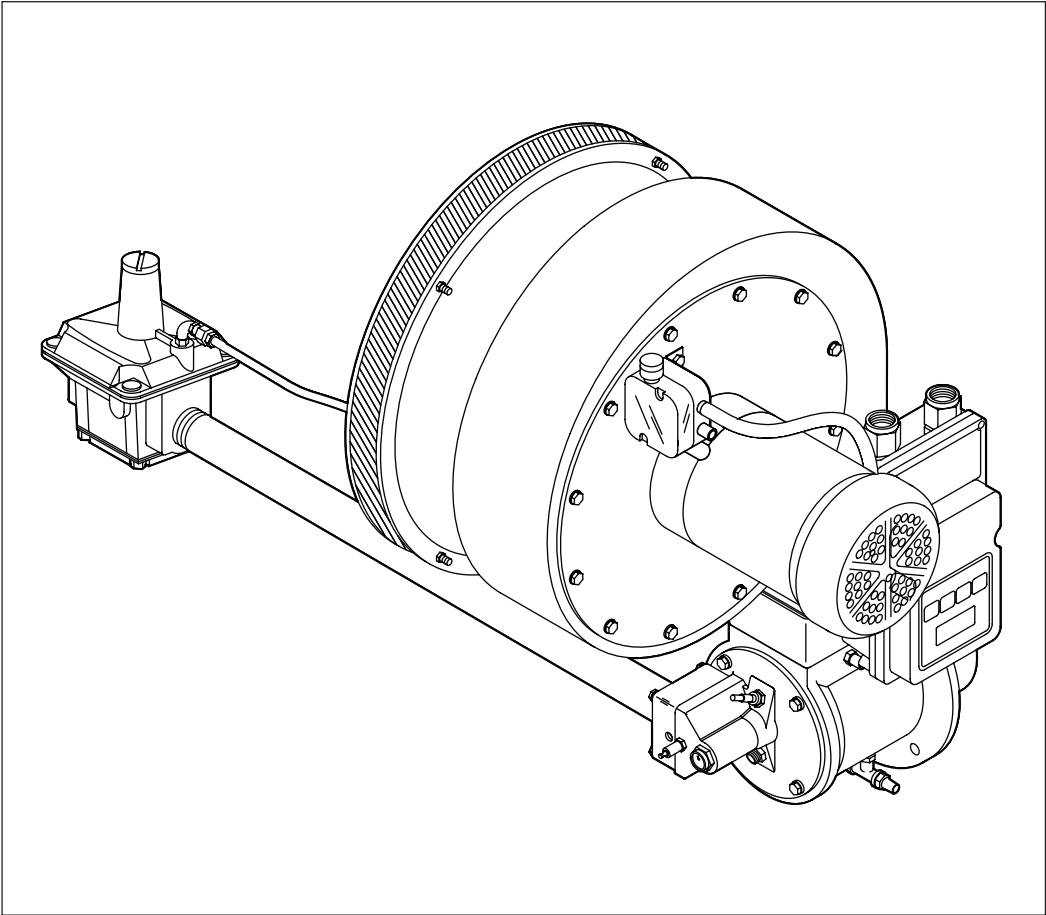

ImmersoPak

Burners

IP Series
version 2



COPYRIGHT

Copyright 2001 by Eclipse Combustion, Inc. All rights reserved worldwide. This publication is protected by federal regulation and shall not be copied, distributed, transmitted, transcribed or translated into any human or computer language, in any form or by any means, to any third parties, without the express written consent of Eclipse Combustion, Inc., Rockford, Illinois, U.S.A.

DISCLAIMER NOTICE

We reserve the right to change the construction and/or configuration of our products at any time without being obliged to adjust earlier supplies accordingly.

The material in this manual is believed adequate for the intended use of the product. If the product, or its individual modules or procedures, are used for purposes other than those specified herein, confirmation of their validity and suitability must be obtained. Eclipse Combustion, Inc. warrants that the material itself does not infringe any United States patents. No further warranty is expressed or implied.

We have made every effort to make this manual as accurate and complete as possible. Should you find errors or omissions, please bring them to our attention so that we may correct them. In this way we hope to improve our product documentation for the benefit of our customers. Please send your corrections and comments to our Documentation Manager.

LIABILITY AND WARRANTY

It must be understood that Eclipse Combustion's liability for its products, whether due to breach of warranty, negligence, strict liability, or otherwise, is limited to the furnishing of such replacement parts and Eclipse Combustion will not be liable for any other injury, loss, damage or expenses, whether direct or consequential, including but not limited to loss of use, income of or damage to material arising in connection with the sale, installation, use of, inability to use or the repair or replacement of Eclipse Combustion's products.

Any operation expressly prohibited in this Guide, any adjustment, or assembly procedures not recommended or authorized in these instructions shall void the warranty.



About this manual

AUDIENCE

This manual has been written for people who are already familiar with all aspects of an immersion burner and its add-on components, also referred to as “the burner system.”

These aspects are:

- design/selection
- use
- maintenance.

The audience is expected to have experience with this kind of equipment.

IMMERSO PAK DOCUMENTS

Design Guide No. 360

- This document

Data Sheets Series 360

- Available for individual IP models
- Required to complete design calculations in this guide

Installation Guide No. 360

- Used with Data Sheet to complete installation

Price List No. 360

- Used to order burners

RELATED DOCUMENTS

- EFE 825 (Combustion Engineering Guide)
- Eclipse bulletins and Info Guides:
610, 710, 720, 730, 744, 760, 930

Purpose

The purpose of this manual is to make sure that the design of a safe, effective and trouble-free combustion system is carried out.

DOCUMENT CONVENTIONS

There are several special symbols in this document. You must know their meaning and importance.

The explanation of these symbols follows below. Please read it thoroughly.



Danger:

Indicates hazards or unsafe practices which WILL result in severe personal injury or even death.

Only qualified and well trained personnel are allowed to carry out these instructions or procedures.

Act with great care and follow the instructions.



Warning:

Indicates hazards or unsafe practices which could result in severe personal injury or damage.

Act with great care and follow the instructions.



Caution:

Indicates hazards or unsafe practices which could result in damage to the machine or minor personal injury.

Act carefully.



Note:

Indicates an important part of the text. Read thoroughly.

HOW TO GET HELP

If you need help, you can contact your local Eclipse Combustion representative. Eclipse representatives worldwide can be found on our web site (www.eclipsenet.com). Eclipse is located at
1665 Elmwood Rd.
Rockford, IL 61103
815-877-3031



Table of Contents

1

About this manual 3

Table of contents 5

2

Introduction 6

Product Description 6

Safety 7

Introduction 7

Safety 7

Capabilities 8

Operator Training 8

Replacement Parts 8

3

System Design 9

Step 1: Burner model selection 9

Step 2: Process equipment design considerations 12

Step 3: Configurable burner options 14

Step 4: Ignition system 17

Step 5: Flame monitoring system 17

Step 6: Main gas shut-off valve train 18

Step 7: Process temperature control system 19

Appendix 20

Key to the system schematics 21

Introduction

1

PRODUCT DESCRIPTION

The ImmersoPak burner (Series IP version 2.00) is a nozzle-mix burner with a packaged combustion air blower that is designed to fire on-ratio (proportional air/gas control) or fixed air on smaller models over a turndown of 10:1. Integral gas and air orifices are provided to ease burner setup. The burner is designed for:

- efficient ratio controlled combustion
- reliable burner operation
- simple burner adjustment
- direct spark ignition
- multiple fuel capability

A wide variety of options and configurations are available due to the modular design of the burner.

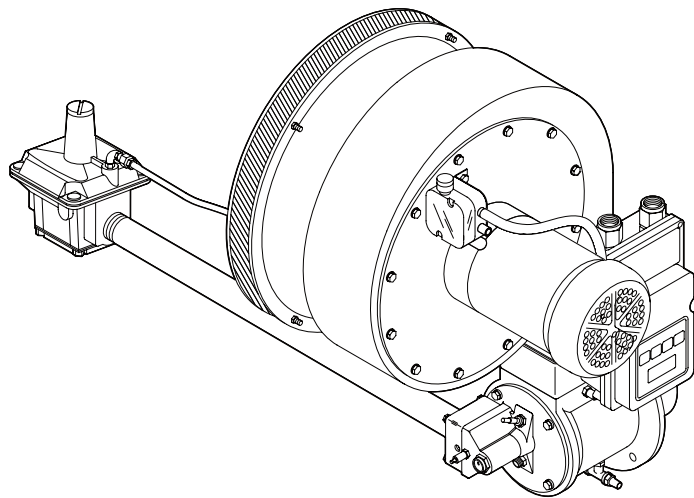

Figure 1 ImmersoPak Burner

Safety

2

INTRODUCTION

SAFETY

In this section you will find important notices about safe operation of a burner system.



Danger:

The burners covered in this manual are designed to mix fuel with air and burn the resulting mixture. All fuel burning devices are capable of producing fires and explosions when improperly applied, installed, adjusted, controlled or maintained.

Do not bypass any safety feature; You can cause fires and explosions.

Never try to light the burner if the burner shows signs of damage or malfunctioning.



Warning:

The burner is likely to have **HOT** surfaces. **Always wear protective clothing when approaching the burner.**



Note:

This manual gives information for the use of these burners for their specific design purpose. Do not deviate from any instructions or application limits in this manual without written advice from Eclipse Combustion.

Read this entire manual before you attempt to start the system. If you do not understand any part of the information in this manual, then contact your local Eclipse representative or Eclipse Combustion before you continue.

CAPABILITIES

Adjustment, maintenance and troubleshooting of the mechanical and the electrical parts of this system should be done by qualified personnel with good mechanical aptitude and experience with combustion equipment.

OPERATOR TRAINING

The best safety precaution is an alert and competent operator. Thoroughly instruct operators so they demonstrate an understanding of the equipment and its operation. Regular retraining must be scheduled to maintain a high degree of proficiency.

REPLACEMENT PARTS

Order replacement parts from Eclipse only. Any customer-supplied valves or switches should carry UL, FM, CSA, CGA and/or CE approval where applicable.



System Design

3

DESIGN

STEP 1: BURNER MODEL SELECTION

Designing a burner system is a straightforward exercise. The steps are:

1. Burner model selection.
 - a. Determine net input required for the tank
 - b. Select tube efficiency
 - c. Calculate gross burner input required
 - d. Determine effective tube length
 - e. Compare gross burner input
 - f. Select burner model
2. Process equipment design considerations
 - a. Tube design
 - b. Application considerations
3. Configurable burner options
4. Ignition system.
5. Flame monitoring system.
6. Main gas shut-off valve train.
7. Process temperature control system.

Determine the net input required to the tank

The net input to the tank is determined from heat balance calculations. These calculations are based on the heatup and steady-state requirements of the process, and take into account surface losses, tank wall losses and tank heat storage. Detailed guidelines for heat balance calculations are in the Eclipse Combustion Engineering Guide (EFE 825).

Select tube efficiency

The efficiency of the tube is the net heat input to the tank divided by the heat input to the tube. Efficiency is determined by the effective tube length. The diameter of the tube has little influence on the efficiency. At a given burner input, the net input to the tank is higher for a longer tube than for a relatively short tube.

It is customary to size conventional immersion tubes for 70% efficiency, a reasonable compromise between fuel economy and tube length. However, small diameter tubes occupy less tank space than conventional tubes, so their length can easily be increased to provide efficiencies of 80% or more.

Calculate the gross burner input

Use this formula to calculate gross burner input in Bth/hr:

$$\frac{\text{net output to tank}}{\text{tube efficiency}} = \text{gross burner input}$$

Determine effective tube length

Find the required effective tube length using the previously selected tube efficiency, net heat input values and the following figure 2. The effective length of a tube is the total centerline length of tube covered by liquid.

Figure 2 Effective Tube Length

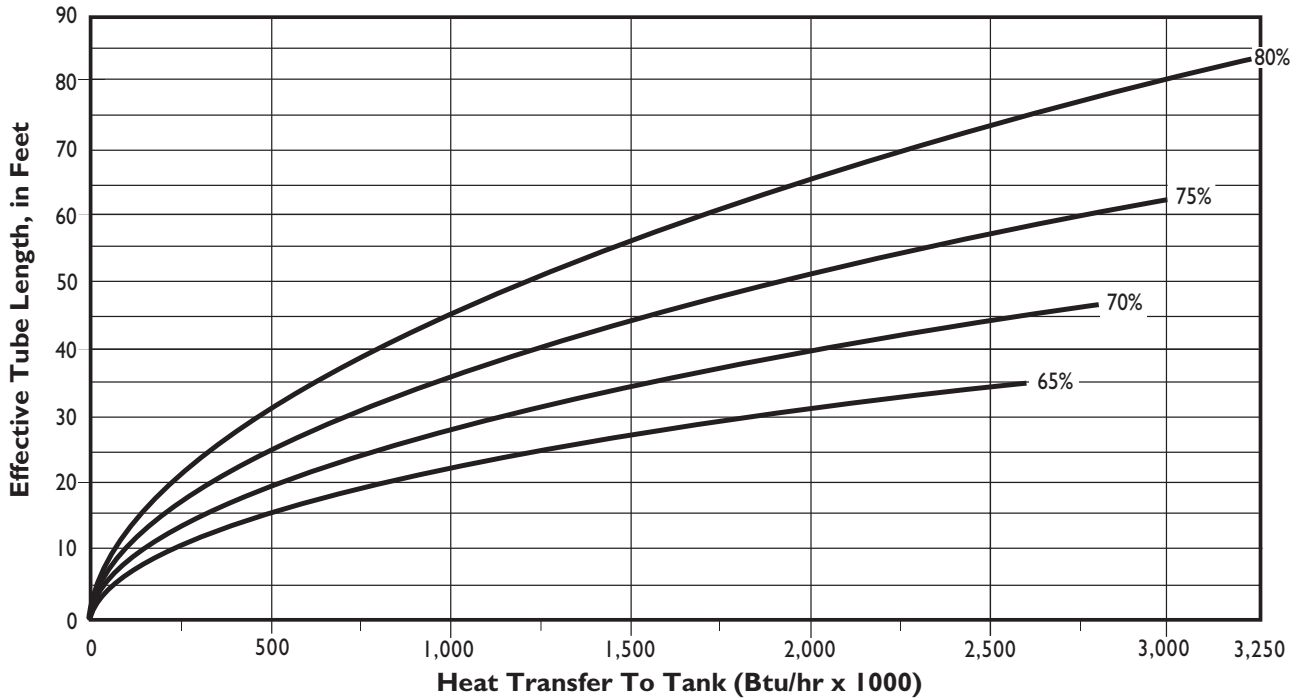

Compare the gross burner input

Compare the gross burner input with the maximum tube input. If the gross burner input is greater than the maximum tube input from the table below, then the size of the immersion tube must be increased.

Table 1

Maximum tube input

Tube I.D. (Inches)	Maximum Input (1000's Btu/hr.)
4	300
5	600
6	1000
8	1750
10	2750
12	4000

Exceeding these inputs may result in burner pulsation or other operational problems.

Sizing Example

Application parameters

- Net heat release required to tank: 1,000,000 Btu/hr
- Efficiency: 70%
- Effective tube length: (Fig. 2) 27'
- Gross Burner Input: $1,000,000 / .70 = 1,428,571$ Btu/hr
- IP008 ImmersoPak Burner: 2,000,000 Btu/hr maximum capacity
- Minimum Tube I.D. : (Table 1) = 8"
- Tube Surface Area/sq. in. = $O.D. \times \pi \times L$
 $O.D. = 8.625$
 $\pi = 3.142$
 $L = \text{Total effective tube length in inches} = (27 \times 12) = 324"$
 $8.625 \times 3.142 \times 324 = 8,780.3$ sq. in.
- Btu/hr/sq.in = Net heat release to tank / sq.in. surface area
 $1,000,000 / 8,780.3 = 113.9$ Btu/sq.in./hr



Note:

If the medium to be heated in the above example was cooking oil, it would be necessary to increase tube length or select a larger tube. It is recommended that you not exceed 50 Btu/hr/sq.in. for cooking oil.

Select burner model

Choose a burner model with a maximum capacity greater than the gross burner input calculated previously. Refer to Figure 3.

Figure 3

Burner Model	Tube Size		Max. Capacity	
	in.	mm	Btu/hr	kW
004IP	4	100	300,000	82
005IP	5	127	500,000	181
006IP	6	152	1,000,000	293
008IP	8	203	2,200,000	645
010IP	10	254	3,000,000	880
012IP	12	305	4,000,000	1172

Additional considerations when selecting the burner size:

- **Power Supply Frequency.** Burner capacity will vary with power supply frequency (50Hz or 60Hz power).
- **Combustion Chamber Pressure.** Consider the effects that large or varying chamber pressures have on burner performance.
- **Altitude.** The maximum burner capacity is reduced by approximately 3% each 1000 feet (300 meters) above sea level.
- **Combustion Air Supply.** Combustion air should be fresh (20.9% O₂) and clean (without corrosives).
- **Combustion Air Temperature.** Changes in air supply temperature can affect the burner capacity. The combustion air supply temperature should not exceed 250° F.
- **Fuel Type.** Variation in calorific value and density will affect burner performance.

STEP 2: PROCESS EQUIPMENT DESIGN CONSIDERATIONS

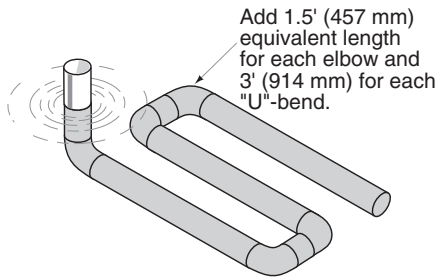

Typical Immersion Tube with Five Standard Elbows

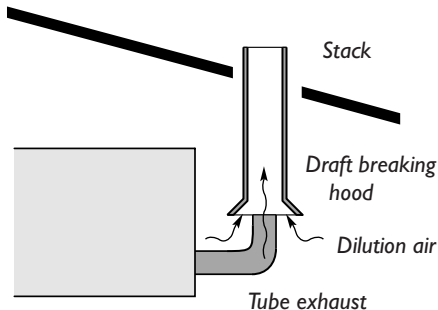

Efficiencies less than 80%

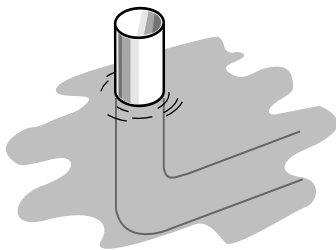

Efficiencies 80% or more

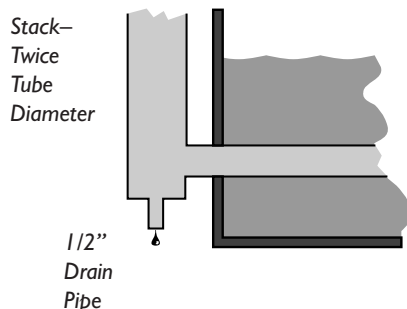

Tube Design

- Use no more than five elbows.
- Use standard or sweep elbows only; do not use miter elbows.
- The first elbow must be at least ten tube diameters from the burner face.
- The tube must be long enough to allow complete combustion before flue gases reach the exhaust stack. See Figure 2 for recommended tube lengths.



Note:

Tube length and elbows increase back pressure and can limit burner input.

Application Considerations

Stack

- Make sure that the stack is large enough to handle the heated exhaust flow plus the dilution air.
- The stack must be at least one pipe size larger than the tube exhaust.



Note:

If you use a common stack for more than one burner, then make sure that the stack is large enough to handle the exhaust flow plus any dilution air from all the burners. Detailed guidelines for flue sizing calculations are in the Eclipse Combustion Engineering Guide (EFE 825).

Draft breaking hood

A draft breaking hood is an open connection between the heater tube exhaust and the exhaust stack. It allows fresh dilution air to pass into the exhaust and mix with the exhaust gases.

The advantages of a draft hood are:

- the burner operation is less sensitive to atmospheric conditions
- the temperature of the exhaust gases is lower when they pass through the roof.



Note:

Leave access between the draft hood and the tube exhaust. Install a damper plate if acoustic feedback occurs in the tube. Damper can increase backpressure limiting burner input.

Condensate provisions

If the immersion tube will operate at efficiencies less than 80%, the exhaust leg can be raised through the liquid surface. For efficiencies of 80% or higher, locate the exhaust stack outside of the tank and provide a drain.



Note:

Regardless of the exhaust design, pitch the immersion tube down towards the exhaust so condensate will not collect at the burner.



Caution:

At efficiencies of 80% or greater, low exhaust temperatures will cause condensation to form in the tube at start-up or during long idling periods. The higher the efficiency the more condensation will increase

To prevent condensation/corrosion from shortening tube life or disrupting burner operation, provide a condensate drain at the exhaust and slope the immersion tube downward, away from the burner.

Tube placement in tank

The tube placement height in the tank should be high enough to avoid the possibility of sludge build-up on the bottom of the tank; however, it should be low enough to avoid tube exposure due to liquid level variations caused by evaporation or displacement. In the latter case use a liquid level switch to shut down the burner.

Applications requiring special consideration:

Zinc phosphate solutions

High heat fluxes break down the phosphate, forming a heavy insulating sludge which can deposit on tube surfaces and can cause rapid tube burnout. To reduce early tube failure, make the immersion tube with electro-polished stainless steel. On Models IP008 and IP010, restrict the maximum inputs to 1.80 MMBtu/hr and 2.83 MMBtu/hr respectively.

Iron phosphate solutions

These are susceptible to the same problem described above for zinc phosphate solutions. To reduce the likelihood of early tube failure, make the immersion tube with stainless steel; but it does not need to be electro-polished.

Cooking oils

To avoid burning the oil, limit heat flux to 50 Btu/hr per square inch of tube area.

Highly viscous liquids

All immersion systems depend on natural convection currents to carry heat away from the tube and throughout the tank. Convection is minimal in high viscosity solutions, such as asphalt, residual oil or molasses. This can severely overheat the liquid around the tube.



Caution

For highly viscous fluids, recirculation may be necessary.

STEP 3: CONFIGURABLE BURNER OPTIONS

Feature 3 Control Options

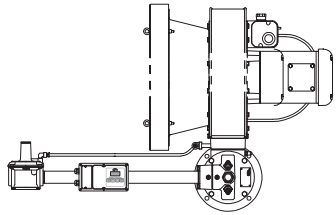

Option 1 – Fixed Air (Modulating Gas)

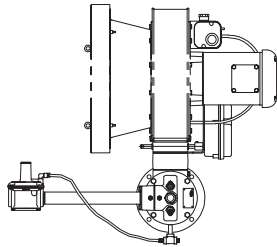

Option 2 – Ratio Control (Modulating Air)

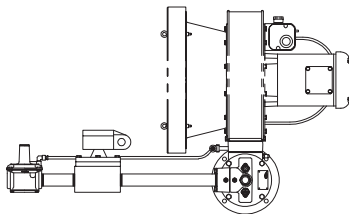

Option 3 – Fixed Air (High - Off)

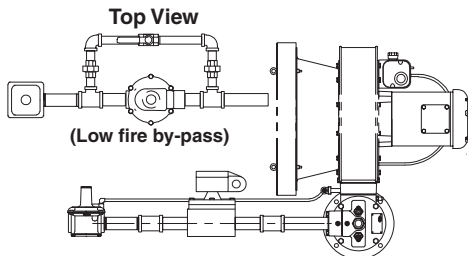

Option 4 – Fixed Air (High - Low)

Feature	Description	Option	Option Description	Model
1	Model	004 005 006 008 010 012	Model:IP004 Model:IP005 Model:IP006 Model: IP008 Model:IP010 Model:IP012	
2	Fuel Type	B N P	Butane Natural Propane	ALL ALL ALL
3	Control Options	1 2 3 4	Modulating Gas Fixed Air Modulating Air Ratio Control High/Off Fixed Air High/Low Fixed Air	004,005 ALL 004,005 004,005
4	Burner Configuration	B C D E	Upright, Right Hand Piping Upright, Left Hand Piping Inverted, Right Hand Piping Inverted, Left Hand Piping	ALL ALL ALL ALL
5	Gas Pipe Connection	B D E N	BSP Piping BSP piping w/ SST braided LL NPT piping w/ SST braided LL NPT Piping	ALL ALL ALL ALL
6	Control Motor	G H M N P Q R T X	EMP 423-5 EMP 424-5 Eclipse Rotary Bracket Only Honeywell Bracket Only Eclipse EMP M7284 C1000 Bracket Only Eclipse Rotary EMA418-1 (High/Low) Less Motor and Bracket	ALL ALL ALL ALL ALL ALL ALL ALL ALL
7	Flame Supervision	F X	Flame Rod No Sensor	004,005,006 ALL
8	Air Pressure Switch	A S X	Dungs 2-20 Dungs 2-20 w/ SST braided hose No Switch	ALL ALL ALL
9	Limit Switch	A B C X	High and Low Limit Switch High Limit Switch Low Limit Switch No Limit Switch	ALL ALL ALL ALL
10	Blower Model	2 3 4 5	Size 2 Blower Size 3 Blower Size 4 Blower Size 5 Blower	004 005 006 008,010,012
11	Power Supply Frequency	1 2 X	60 Hz Blower 50 Hz Blower None	ALL 004,005,006,008,010 ALL
12	Pressure and Flow	2B 3A 4A 5B 5D XX	6 in, 5500 cfh 6 in, 8250 cfh 6 in, 16,500 cfh 10 in, 44,000 cfh 15 INCH, 44,000 SCFH No Blower	004 005 006 008,010 012 ALL
13	Blower Motor Type	AA AB AC AD AE BA BB CA CC CD DB DC XX	115/208-230/1, TEFC (NEMA) 208-230/460/3, TENV (NEMA) 575/3, TENV (NEMA) 115/1, TEFC (NEMA) 208-230/1, TEFC (NEMA) 230/460/3, AUTO (NEMA) 460/3 AUTO TEFC(NEMA 60HZ) 220-240/380-415/3, TEFC (IEC, 50Hz) 230/1, TEFC (IEC, 50Hz) 115/1, TEFC (IEC, 50Hz) 208-230/460/3, TENV (NEMA) 575/3, TENV (NEMA) No Motor	005,006,008,010 005,006,008,010,012 005,006,008,010,012 004 004 005,006 008,010,012 004,005,006,008,010 004,005,006 004,005,006 004 004 ALL
14	Blower Inlet	A B D X	Standard Grill Round Inlet Filter Filter Silencer No Filter	ALL ALL ALL ALL
15	Blower Configuration	R X	Right Hand Motor Not applicable	ALL ALL

Feature 4 Burner Configuration

Upright

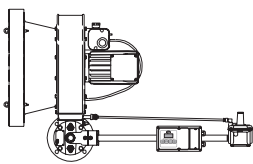

Right Hand Piping
(Option B)

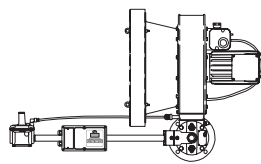

Left Hand Piping
(Option C)

Inverted

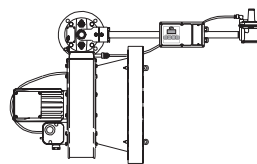

Right Hand Piping
(Option D)

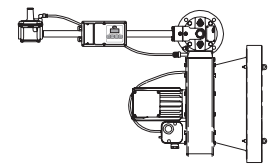

Left Hand Piping
(Option E)

STEP 3: CONFIGURABLE BURNER OPTIONS (CONTINUED)

Burner Model

Previously selected in Step 1

Fuel Type

Fuel	Symbol	Gross Heating Value	Specific Gravity
Natural gas	CH ₄ 90%+	1000 BTU/ft ³ (40 MJ/m ³)	0.60
Propane	C ₃ H ₈	2570 BTU/ft ³ (103 MJ/m ³)	1.52
Butane	C ₄ H ₁₀	3250 BTU/ft ³ (130 MJ/m ³)	1.95
BTU/ft ³ @ standard conditions (MJ/m ³ @ normal conditions)			

If using an alternative fuel supply, contact Eclipse Combustion with an accurate breakdown of the fuel components.

Air Supply

When a standard ImmersoPak Version 2.00 burner is ordered, a combustion air blower is supplied and mounted directly to the burner body.

Control options

ImmersoPak burners are available with two different control systems: Modulating Air (Ratio Control) and Fixed Air. Fixed air models can be ordered to operate as modulating gas, high-low or on-off. Models IP006, IP008, IP010 and IP012 are available as Modulating Air burners only. Refer to illustrations at the left of page 14.

Burner Configuration

Select configuration. Refer to illustrations at the bottom of page 14.

Gas Pipe Connection

Select the gas pipe connection thread type and loading line option.

The ratio regulator is threaded using the customer selected pipe thread option.

Control Motor – Modulating air or gas

Select a control motor. Standard control motor options include various models which Eclipse will mount to the burner. ImmersoPaks can be ordered with control motor bracket and mounting hardware only. Customer supplied control motors must conform to the these specifications:

- rotation not to exceed 2 rpm.
- minimum torque of 25 in-lb. (2,8 Nm)
- 90° stroke.
- continuous modulating or high/low modulating control.
- reversible direction of rotation.

STEP 3: CONFIGURABLE BURNER OPTIONS (CONTINUED)

Flame Supervision

Select a flame rod or an ultraviolet (U.V.) scanner. Both are available for use on IP004, IP005 and IP006. If a flame rod is selected, it will be factory mounted in the burner. If a U.V. scanner is selected, it must be ordered separately.

Air Flow Switch

The air flow switch provides a signal to the monitoring system when there is not enough air pressure from the blower. If a switch is selected, it will be factory mounted.



Warning:

Eclipse Combustion supports the NFPA regulation requiring, as a minimum standard for main gas shut-off systems, the use of an air pressure switch in conjunction with other system components.

Limit Switch

A low limit switch is available for all models .

Power Supply Frequency

Select the 50Hz or 60Hz option. The 50Hz blower motors have IEC frames and are CE marked. The 60Hz motors have NEMA frames.

Pressure & Flow

All models of the ImmersoPak version 2.00 include a combustion air blower.

Blower Motor Type

Motor types include various options: voltages, single or three phase, TEFC or automotive duty enclosures.

Blower Inlet

When selecting an inlet, consider the following:

- amount and size of particles in the air.
- sound requirements.
- space limitations.
- cleanliness requirements of the process.

Motor Orientation

All ImmersoPaks are available with a left-hand or right-hand blower motor.

STEP 4: IGNITION SYSTEM

For the ignition system you should use:

- 6000 VAC transformers
- full wave spark transformers
- one transformer per burner.

Do not use:

- 10,000 VAC transformers
- twin outlet transformers
- distributor type transformers
- half wave spark transformers.

ImmersoPak burners will ignite reliably at any input within the ignition zone shown in the appropriate burner data sheet. However, it is recommended that low fire start be used. Local safety and insurance requirements demand that you limit the maximum time that a burner takes to ignite. These time limits vary from country to country.

The time that a burner takes to ignite depends on:

- the distance between the gas shut-off valve and the burner
- the air/gas ratio
- the gas flow at start conditions.

In the USA, with a time of 15 seconds to ignition, there should be sufficient time to ignite the burners. It is possible, however, to have the low fire too low to ignite within the time limit. Under these circumstances you must consider the following options:

- start at higher input levels
- resize and/or relocate the gas controls

A flame monitoring system consists of two main parts:

- a flame sensor
- flame monitoring control

Flame sensor

There are two types that you can use for an Immersojet burner:

- U.V. scanner
- flame rod

You can find U.V. scanner information in:

- Info Guide 852; 90° U.V. scanner
- Info Guide 854; straight U.V. scanner
- Instruction Manual 855; Solid State UV/IR scanner
- Info Guide 856; self-check U.V. scanner.

You can find flame rod information in:

- Bulletin / Info Guide 832

STEP 5: FLAME MONITORING SYSTEM

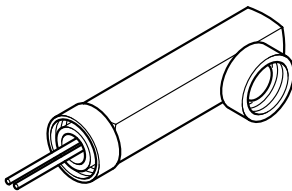

U.V. scanner

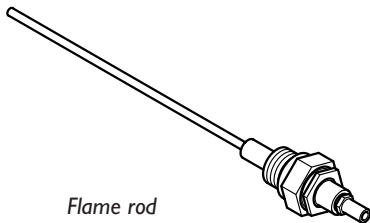

Flame rod

Step 6: Main gas shut-off valve train



Flame Monitoring Control

The flame monitoring control is the equipment that processes the signal from the flame rod or the U.V. scanner.

For flame monitoring control you may select several options:

- flame monitoring control for each burner: if one burner goes down, only that burner will be shut off
- multiple burner flame monitoring control: if one burner goes down, all burners will be shut off

There are three recommended flame monitoring controls:

- Bi-flame series; see Instruction Manual 826
- Multi-flame series 6000; see Instruction Manual 820
- Veri-flame; see Instruction Manual 818

Other manufacturer's flame monitoring systems can be used with the burner if spark is maintained for a fixed time interval and is not interrupted when a flame signal is detected during trial for ignition.

Consult Eclipse

Eclipse can help you design and obtain a main gas shut-off valve train that complies with the current safety standards.

The shut-off valve train must comply with all the local safety standards set by the authorities that have jurisdiction.

For details, please contact your local Eclipse Combustion representative or Eclipse Combustion.

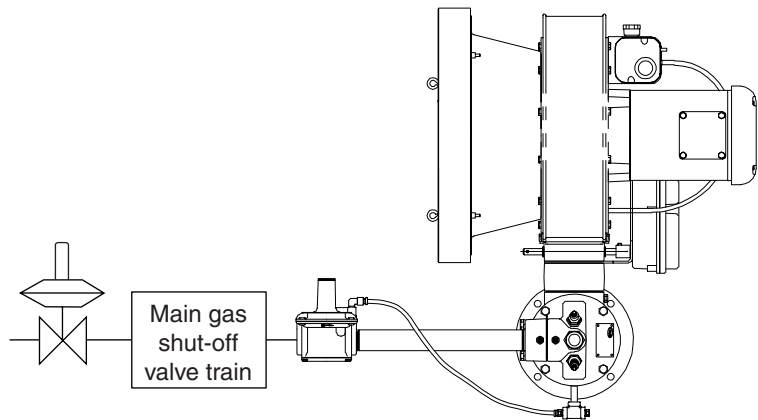

Note

Eclipse Combustion supports NFPA regulations (two shut-off valves) as a minimum standard for main gas safety shut-off systems.

**STEP 7: PROCESS
TEMPERATURE CONTROL
SYSTEM**

Consult Eclipse

The process temperature control system is used to control and monitor the temperature of the system. In a control system, a control signal is sent from a process temperature controller (sold separately) to the control motor. (Refer to Bulletin 905C.) The control motor modulates the air or gas butterfly valve (BV) which changes the input level and hence the temperature.

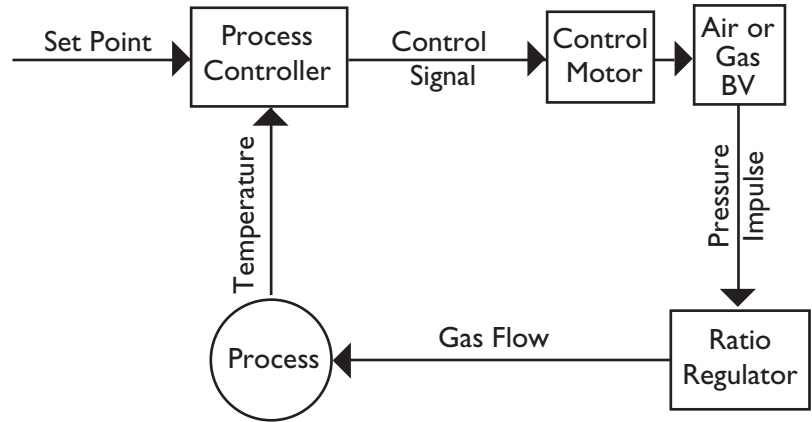

There is a wide variety of control and measuring equipment available. For details, please contact your local Eclipse Combustion representative or Eclipse Combustion.



Appendix

CONVERSION FACTORS

Metric to English.

FROM	TO	MULTIPLY BY
cubic meter (m ³)	cubic foot (ft ³)	35.31
cubic meter/hour (m ³ /h)	cubic foot/hour (cfh)	35.31
degrees Celsius (°C)	degrees Fahrenheit (°F)	(°C × 1.8) + 32
kilogram (kg)	pound (lb)	2.205
kilowatt (kW)	Btu/hr	3414
meter (m)	foot (ft)	3.28
millibar (mbar)	inches water column ("wc)	0.401
millibar (mbar)	pounds/sq in (psi)	14.5 × 10 ⁻³
millimeter (mm)	inch (in)	3.94 × 10 ⁻²

Metric to Metric.











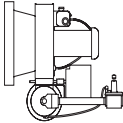
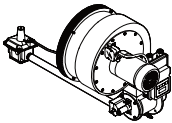

FROM	TO	MULTIPLY BY
kiloPascals (kPa)	millibar (mbar)	10
meter (m)	millimeter (mm)	1000
millibar (mbar)	kiloPascals (kPa)	0.1
millimeter (mm)	meter (m)	0.001

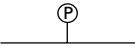

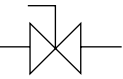

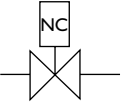
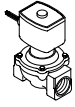
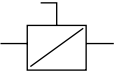
English to Metric.

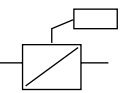
FROM	TO	MULTIPLY BY
Btu/hr	kilowatt (kW)	0.293 × 10 ⁻³
cubic foot (ft ³)	cubic meter (m ³)	2.832 × 10 ⁻²
cubic foot/hour (cfh)	cubic meter/hour (m ³ /h)	2.832 × 10 ⁻²
degrees Fahrenheit (°F)	degrees Celsius (°C)	(°F – 32) ÷ 1.8
foot (ft)	meter (m)	0.3048
inches (in)	millimeter (mm)	25.4
inches water column ("wc)	millibar (mbar)	2.49
pound (lb)	kilogram (kg)	0.454
pounds/sq in (psi)	millibar (mbar)	68.95

KEY TO SYSTEM SCHEMATICS

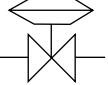
These are the symbols used in the schematics.

SYMBOL	APPEARANCE	NAME	REMARKS	BULLETIN/ INFO GUIDE
		ImmersoPak burner		
		Main gas shutoff valve train	Eclipse Combustion, Inc. strongly endorses NFPA as a minimum	756
		Combustion air blower	The combustion air blower provides the combustion air pressure to the burner (s).	610
		Air pressure switch	The air pressure switch gives a signal to the safety system when there is not enough air pressure from the blower.	610 I-354
		Gas cock	Gas cocks are used to manually shut off the gas supply on both sides of the main gas shut-off valve train.	710
		Solenoid valve (normally closed)	Solenoid valves are used to automatically shut off the gas supply on a bypass gas system or on small capacity burner systems.	760
		Manual butterfly valve	Manual butterfly valves are used to balance the air or gas flow at each burner, and/or to control the zone flow.	720
		Automatic butterfly valve	Automatic butterfly valves are typically used to set the output of the system.	720

SYMBOL	APPEARANCE	NAME	REMARKS	BULLETIN/ INFO GUIDE
		Ratio regulator	<p>A ratio regulator is used to control the air/gas ratio. The ratio regulator is a sealed unit that adjusts the gas flow in ratio with the air flow. To do this, it measures the air pressure with a pressure sensing line, the impulse line. This impulse line is connected between the top of the ratio regulator and the air supply line.</p> <p>The cap must stay on the ratio regulator after adjustment.</p>	742
		CRS valve	<p>A CRS valve is used in a high/low time-proportional control system to quickly open and close the air supply.</p>	744
		Pressure taps	<p>The schematics show the advised positions of the pressure taps.</p>	
		Impulse line	<p>The impulse line connects the ratios regulator to the air supply line.</p>	



Eclipse Combustion
www.eclipsenet.com